

**Series**  
**TFI243-630**

## High Frequency Inverter grade Capsule Thyristor Type TFI243-630

Low switching losses  
Low reverse recovery charge  
Distributed amplified gate for high di/dt

Maximum mean on-state current					$I_{TAV}$	<b>630 A</b>		
Maximum repetitive peak off-state and reverse voltage					$U_{DRM}$	<b>800 ÷ 1500 V</b>		
Turn-off time					$U_{RRM}$			
					$t_q$	<b>16; 20; 25 <math>\mu</math>s</b>		
$U_{DRM}, U_{RRM}, V$	800	900	1000	1100	1200	1300	1400	1500
Voltage code	8	9	10	11	12	13	14	15
$T_{vj}, ^\circ C$	- 60 ÷ 125							

### MAXIMUM ALLOWABLE RATINGS

Symbols and parameters		Units	TFI243-630	Conditions
$I_{TAV}$	Mean on-state current	A	630 867	$T_c=80^\circ C$ , $T_c=55^\circ C$ , 180° half-sine wave, 50 Hz
$I_{TRMS}$	RMS on-state current	A	989	$T_c=80^\circ C$
$I_{TSM}$	Surge on-state current	kA	11,0 12,0	$T_{vj}=125^\circ C$ $T_{vj}=25^\circ C$
$I^2t$	Limiting load integral	$kA^2s$	605 720	$T_{vj}=125^\circ C$ $T_{vj}=25^\circ C$
$U_{DRM}, U_{RRM}$	Repetitive peak off-state and reverse voltage	V	800 ÷ 1500	$T_j \min \leq T_{vj} \leq T_{jM}$ 180° half-sine wave, 50 Hz Gate open
$U_{DSM}, U_{RSM}$	Non-repetitive peak off-state and reverse voltage	V	880 ÷ 1600	$T_j \min \leq T_{vj} \leq T_{jM}$ 180° half-sine wave $t_p=10$ ms, Single pulse Gate open
$(di_T/dt)_{crit}$	Critical rate of rise of on-state current : non - repetitive repetitive	$A/\mu s$	2000 1250	$T_{vj}=125^\circ C$ ; $U_D=0,67 U_{DRM}$ , Gate pulse : 10V, 5 $\Omega$ , 1 $\mu s$ rise time, 10 $\mu s$
$U_{RGM}$	Peak reverse gate voltage	V	5	$T_j \min \leq T_{vj} \leq T_{jM}$
$T_{stg}$	Storage temperature	$^\circ C$	-60 ÷ 80	
$T_{vj}$	Junction temperature	$^\circ C$	-60 ÷ 125	

### CHARACTERISTICS

$U_{TM}$	Peak on-state voltage	V	2,3	$T_{vj}=25^\circ C$ , $I_{TM}=3,14 I_{TAV}$
$U_{T(TO)}$	Threshold voltage	V	1,3	$T_{vj}=125^\circ C$
$R_T$	On-state slope resistance	$m\Omega$	0,57	$1,57 I_{TAV} < I_T < 4,71 I_{TAV}$
$I_{DRM}$ $I_{RRM}$	Repetitive peak off-state and reverse current	mA	70 70	$T_{vj}=125^\circ C$ , $U_D = U_{DRM}$ $U_R = U_{RRM}$

## CHARACTERISTICS

Symbols and parameters		Units	TFI243-630	Conditions
$I_L$	Latching current	A	8	$T_{vj}=25^{\circ}\text{C}, U_D=12\text{V}$ Gate pulse : 10V, 5 $\Omega$ , 1 $\mu\text{s}$ rise time, 10 $\mu\text{s}$
$I_H$	Holding current	A	0,5	$T_{vj}=25^{\circ}\text{C}, U_D=12\text{V}$ , Gate open
$U_{GT}$	Gate trigger direct voltage	V	2,5 5,0	$T_{vj}=25^{\circ}\text{C}$ , $T_{vj}=-60^{\circ}\text{C}$ $U_D=12\text{V}$
$I_{GT}$	Gate trigger direct current	A	0,3 0,85	$T_{vj}=25^{\circ}\text{C}$ , $T_{vj}=-60^{\circ}\text{C}$
$U_{GD}$	Gate non-trigger direct voltage	V	0,25	$T_{vj}=125^{\circ}\text{C}, U_D = 0,67 U_{DRM}$
$I_{GD}$	Gate non-trigger direct current	mA	10	Direct gate current
$t_{gd}$	Delay time	$\mu\text{s}$	1,6	$T_{vj}=25^{\circ}\text{C}, U_D=500\text{V}$ $I_{TM} = 630\text{ A}$
$t_{gt}$	Turn-on time	$\mu\text{s}$	2,5	Gate pulse : 10V, 5 $\Omega$ , 1 $\mu\text{s}$ rise time, 10 $\mu\text{s}$
$t_q$	Turn-off time	$\mu\text{s}$	16÷25 20÷32	$T_{vj}=125^{\circ}\text{C}, I_{TM}=630\text{ A}$ $di_R/dt = 10\text{ A}/\mu\text{s}, U_R=100\text{V}$ $U_D = 0,67 U_{DRM}$ $du_D/dt=50\text{ V}/\mu\text{s}$ $du_D/dt=200\text{ V}/\mu\text{s}$
$Q_{rr}$	Recovered charge	$\mu\text{C}$	250	$T_{vj}=125^{\circ}\text{C}, I_{TM}=630\text{ A}$ $di_R/dt = 50\text{ A}/\mu\text{s}, U_R=100\text{V}$
$t_{rr}$	Reverse recovery time	$\mu\text{s}$	4,0	
$I_{rrM}$	Peak reverse recovery current	A	125	
$(du_D/dt)_{crit}$	Critical rate of rise of off-state voltage	V/ $\mu\text{s}$	500 1000	$T_{vj}=125^{\circ}\text{C}, U_D = 0,67 U_{DRM}$ Gate open
$R_{thjc}$	Thermal resistance junction to case	$^{\circ}\text{C}/\text{W}$	0,032	Direct current, double side cooled

## ORDERING

	TFI	243	630	14	7	7	3	
	1	2	3	4	5	6	7	

1. Fast thyristor with interdigitated gate structure.
2. Design version.
3. Mean on-state current, A.
4. Voltage code (14=1400V).
5. Critical rate of rise of off-state voltage ( $6 \geq 500\text{ V}/\mu\text{s}$ ,  $7 \geq 1000\text{ V}/\mu\text{s}$ )
6. Group of turn-off time ( $du_D/dt=50\text{ V}/\mu\text{s}$ ,  $5 \leq 25\ \mu\text{s}$ ,  $6 \leq 20\ \mu\text{s}$ ,  $7 \leq 16\ \mu\text{s}$ )
7. Group of turn-on time ( $3 \leq 2,5\ \mu\text{s}$ )

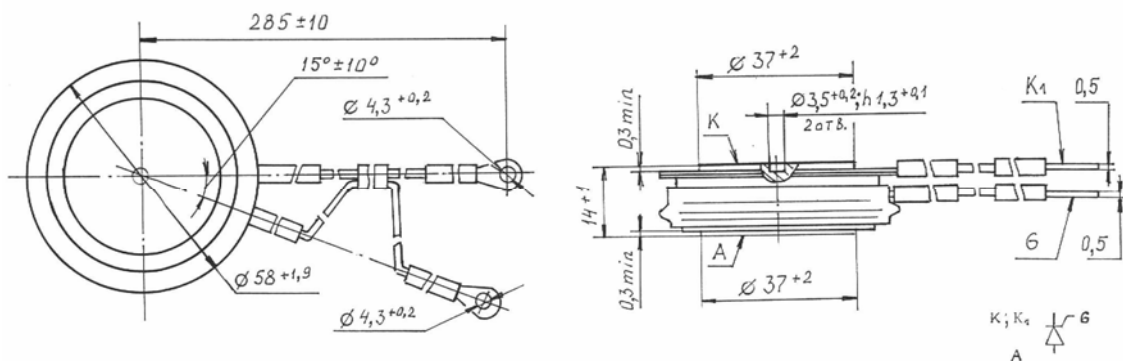

Mounting force : 13÷19 kN

Weight : 210 grams

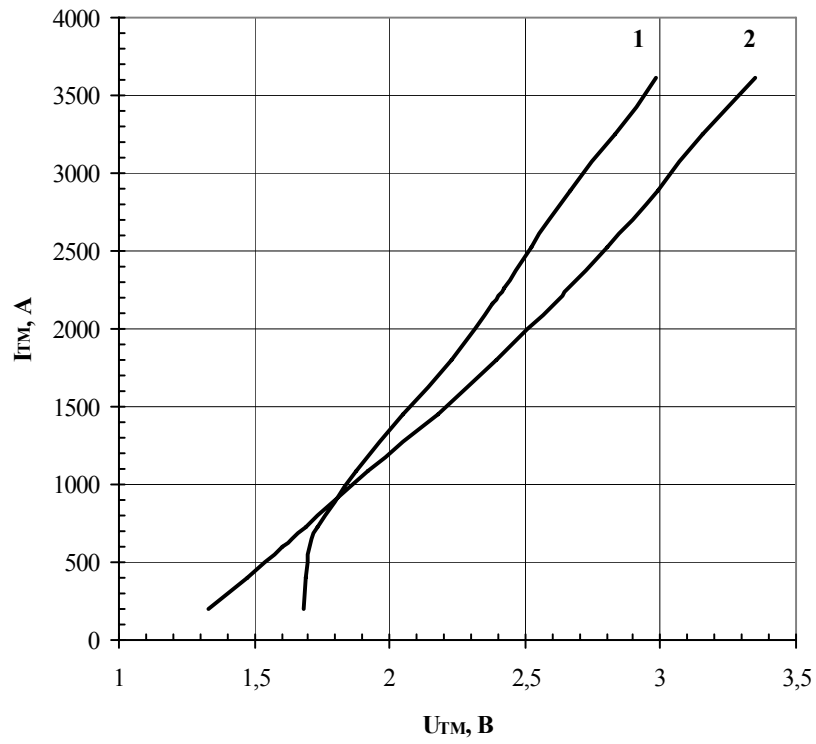

**Fig. 1** On-state characteristics of Limit device

1 –  $T_j = 25\text{ }^\circ\text{C}$

2 –  $T_j = 125\text{ }^\circ\text{C}$

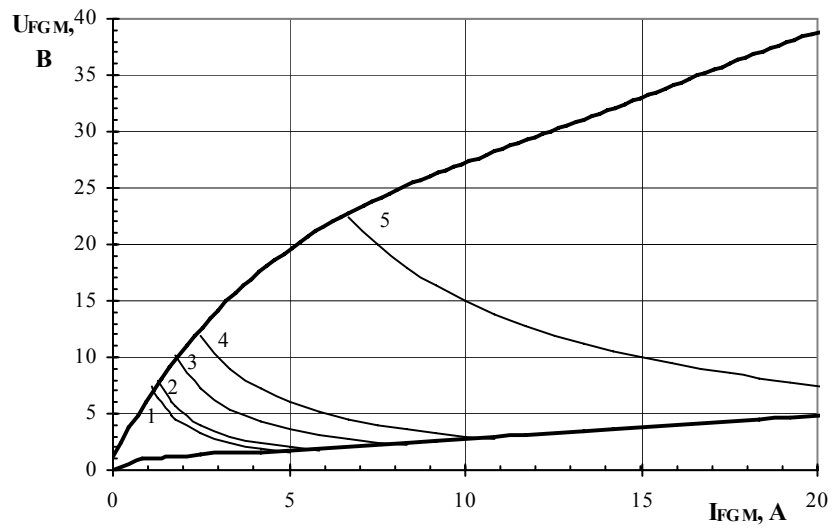

Maximum peak gate power loss

Position	On-Off time ratio	Gate pulse length, ms	Gate Pulse Power, W
1	1	DC	8
2	2	10	10
3	20	1	18
4	40	0.5	30
5	200	0.1	150

**Fig. 2** Gate characteristics

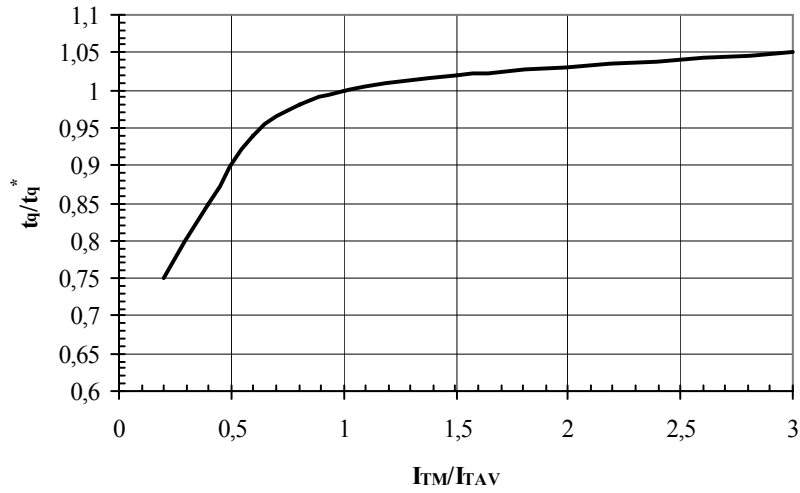

**Fig. 3** Turn-off time  $t_q$  vs. On-state peak current  $I_{TM}$

Conditions:  $T_j=T_{j\max}$ ;  $di_R/dt=10\text{ A}/\mu\text{s}$ ;  $V_R=100\text{ V}$ ;  $dv_D/dt=50\text{ V}/\mu\text{s}$ ;  $V_D=0.67\cdot V_{DRM}$   
 Typical changes of  $t_q$  are normalized to the  $t_q^*$  ( $t_q^*$  – see data sheet,  $dv_D/dt=50\text{ V}/\mu\text{s}$ )

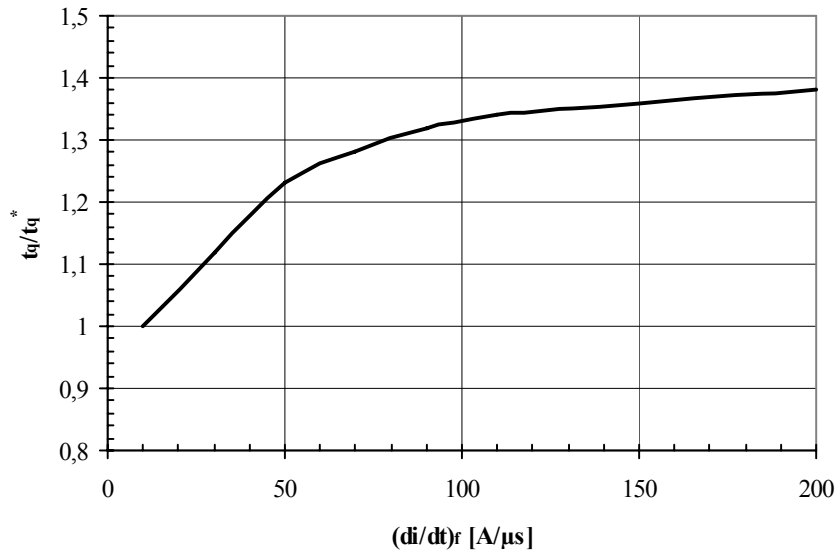

**Fig. 4** Turn-off time  $t_q$  vs. Rate of fall of on-state current  $di_R/dt$

Conditions:  $T_j=T_{j\max}$ ;  $I_{TM}=I_{TAV}$ ;  $V_R=100\text{ V}$ ;  $dv_D/dt=50\text{ V}/\mu\text{s}$ ;  $V_D=0.67\cdot V_{DRM}$   
 Typical changes of  $t_q$  are normalized to the  $t_q^*$  ( $t_q^*$  – see data sheet,  $dv_D/dt=50\text{ V}/\mu\text{s}$ )

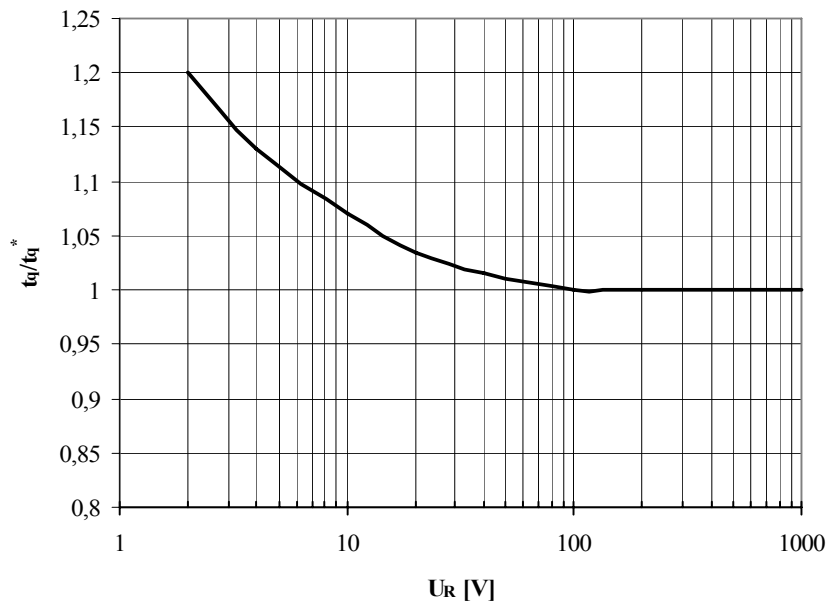

**Fig. 5** Turn-off time  $t_q$  vs. Reverse voltage  $V_R$

Conditions:  $T_j=T_{j\max}$ ;  $I_{TM}=I_{TAV}$ ;  $di_R/dt=10\text{ A}/\mu\text{s}$ ;  $dv_D/dt=50\text{ V}/\mu\text{s}$ ;  $V_D=0.67\cdot V_{DRM}$   
 Typical changes of  $t_q$  are normalized to the  $t_q^*$  ( $t_q^*$  – see data sheet,  $dv_D/dt=50\text{ V}/\mu\text{s}$ )

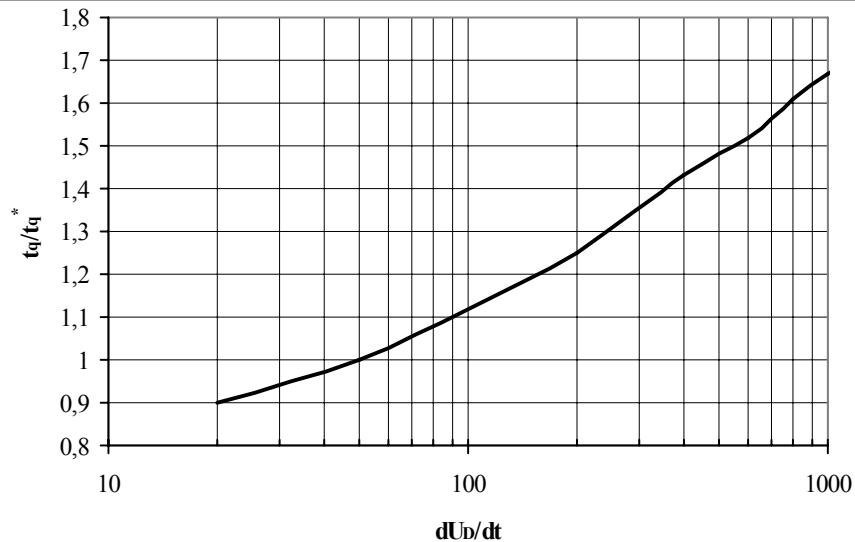

**Fig. 6** Turn-off time  $t_q$  vs. Rate of rise of commutating voltage  $dv_D/dt$

Conditions:  $T_j=T_{j\max}$ ;  $I_{TM}=I_{TAV}$ ;  $di_R/dt=10\text{ A}/\mu\text{s}$ ;  $V_R=100\text{ V}$ ;  $V_D=0.67\cdot V_{DRM}$   
 Typical changes of  $t_q$  are normalized to the  $t_q^*$  ( $t_q^*$  – see data sheet,  $dv_D/dt=50\text{ V}/\mu\text{s}$ )

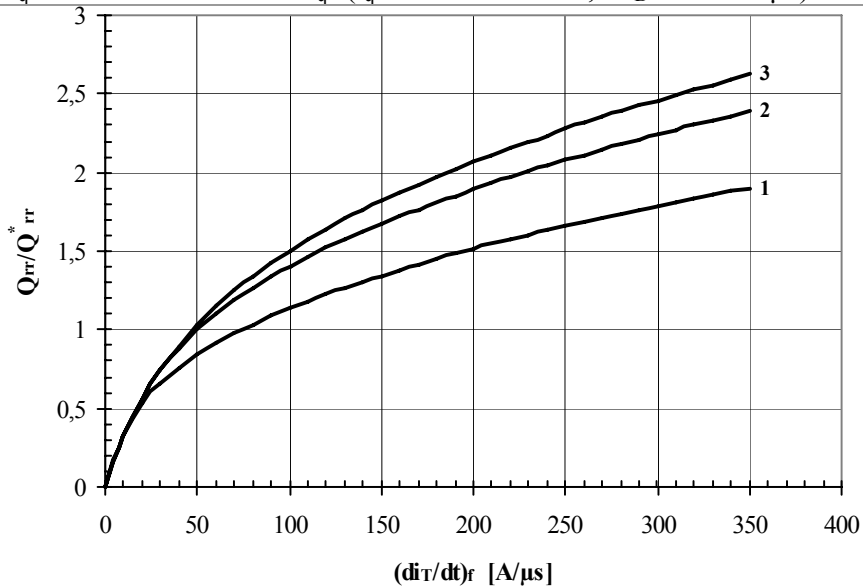
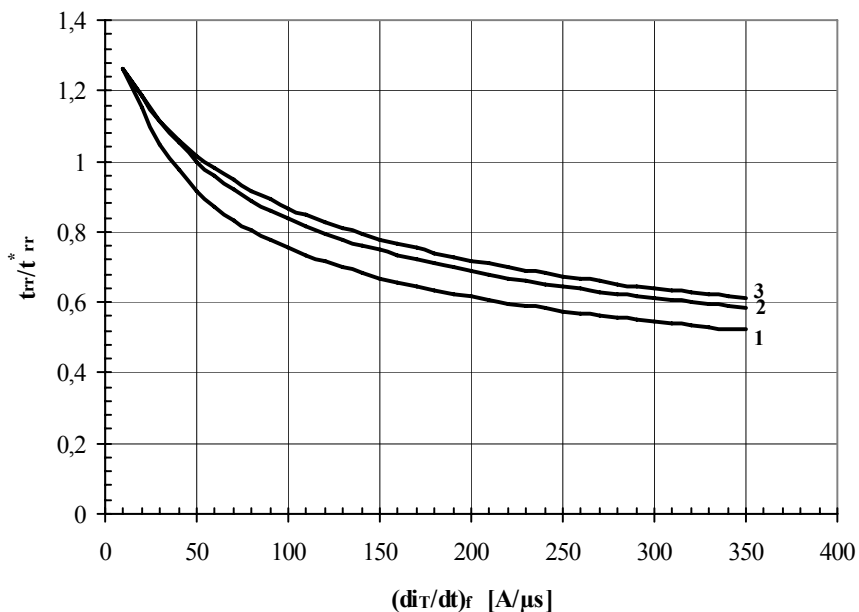

**Fig. 7** Reverse recovery charge  $Q_{rr}$ , vs. Rate of fall of on-state current  $di_R/dt$

- 1 –  $I_{TM} = 0.5\cdot I_{TAV}$
- 2 –  $I_{TM} = I_{TAV}$ ,
- 3 –  $I_{TM} = 1.5\cdot I_{TAV}$

Conditions:  $T_j=T_{j\max}$ ;  $V_R=100\text{ V}$

Typical changes of  $Q_{rr}$  are normalized to the  $Q_{rr}^*$  ( $Q_{rr}^*$  – see data sheet)



**Fig. 8** Reverse recovery time  $t_{rr}$  vs. Rate of fall of on-state current  $di_R/dt$

1 –  $I_{TM} = 0.5 \cdot I_{TAV}$

2 –  $I_{TM} = I_{TAV}$ ,

3 –  $I_{TM} = 1.5 \cdot I_{TAV}$

Conditions:  $T_j = T_{j \max}$ ;  $V_R = 100$  V

Typical changes of  $t_{rr}$  are normalized to the  $t_{rr}^*$  ( $t_{rr}^*$  – see data sheet)

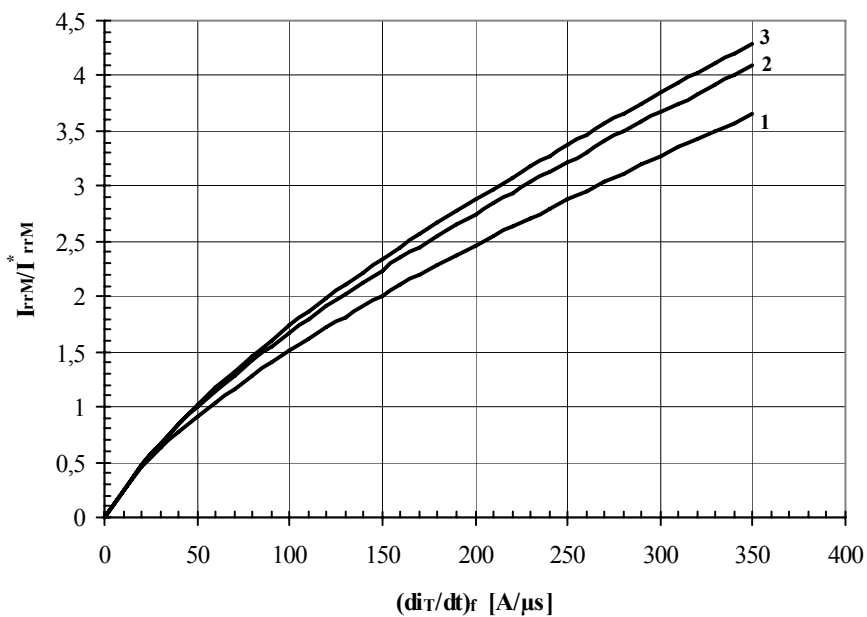

**Fig. 9** Peak reverse recovery current  $I_{rrM}$  vs. Rate of fall of on-state current  $di_R/dt$

1 –  $I_{TM} = 0.5 \cdot I_{TAV}$

2 –  $I_{TM} = I_{TAV}$ ,

3 –  $I_{TM} = 1.5 \cdot I_{TAV}$

Conditions:  $T_j = T_{j \max}$ ;  $V_R = 100$  V

Typical changes of  $I_{rrM}$  are normalized to the  $I_{rrM}^*$  ( $I_{rrM}^*$  – see data sheet)

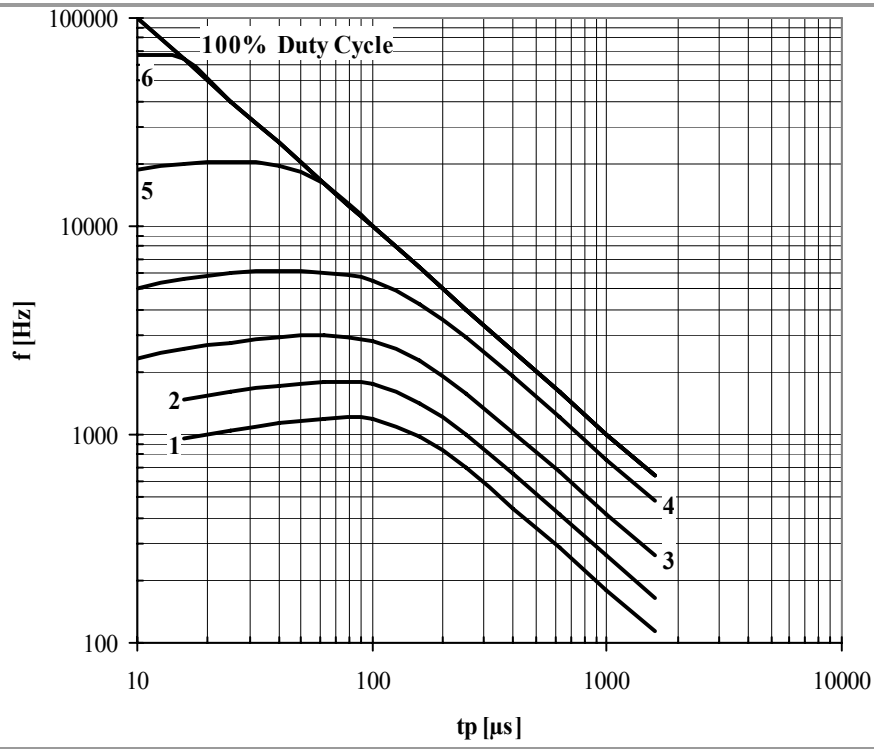

**Fig. 10** Sine wave frequency ratings

- 1 –  $I_{TM} = 5000$  A
- 2 –  $I_{TM} = 4000$  A
- 3 –  $I_{TM} = 3000$  A
- 4 –  $I_{TM} = 2000$  A
- 5 –  $I_{TM} = 1000$  A
- 6 –  $I_{TM} = 500$  A

Conditions:  $V_R \leq 3$  V;  $T_C = 55$  °C

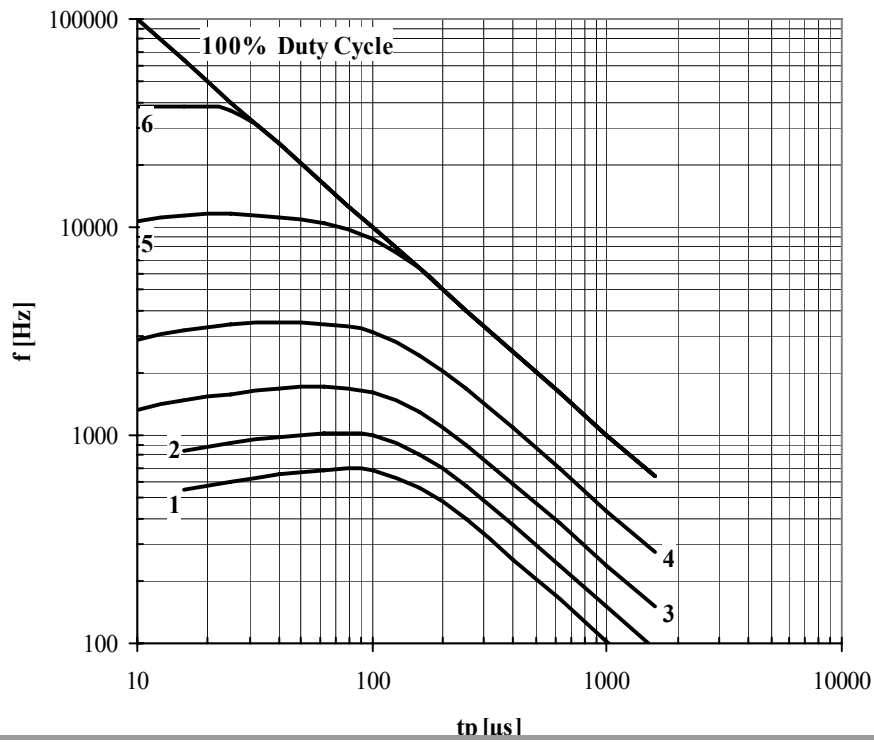

**Fig. 11** Sine wave frequency ratings

- 1 –  $I_{TM} = 5000$  A
- 2 –  $I_{TM} = 4000$  A
- 3 –  $I_{TM} = 3000$  A
- 4 –  $I_{TM} = 2000$  A
- 5 –  $I_{TM} = 1000$  A
- 6 –  $I_{TM} = 500$  A
- 7 –  $I_{TM} = 250$  A

Conditions:  $V_R \leq 3$  V;  $T_C = 80$  °C

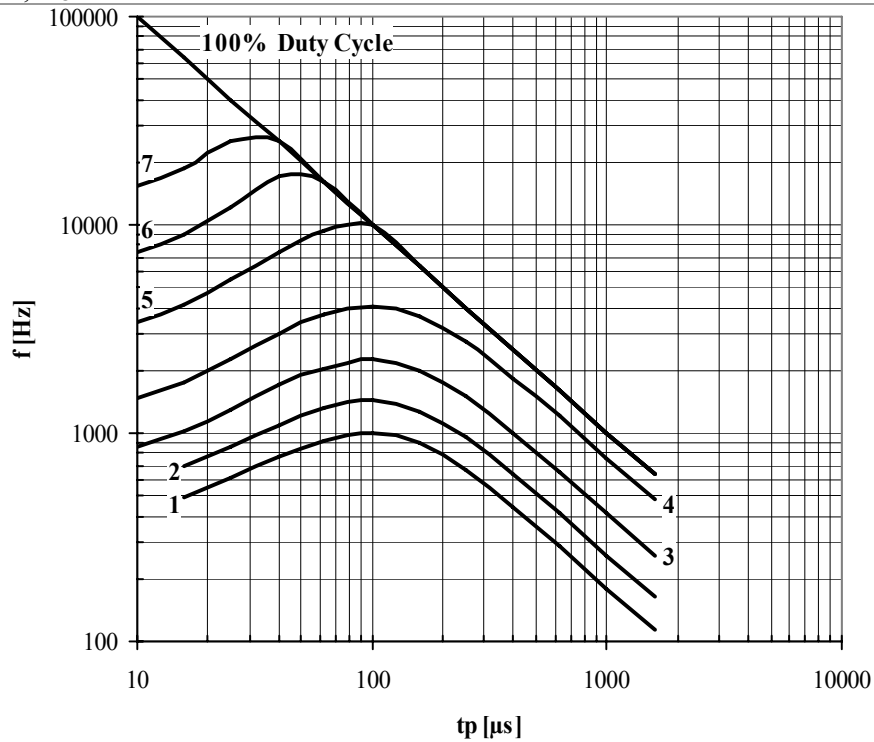

**Fig. 12** Sine wave frequency ratings

- 1 –  $I_{TM} = 5000$  A
- 2 –  $I_{TM} = 4000$  A
- 3 –  $I_{TM} = 3000$  A
- 4 –  $I_{TM} = 2000$  A
- 5 –  $I_{TM} = 1000$  A
- 6 –  $I_{TM} = 500$  A
- 7 –  $I_{TM} = 250$  A

Conditions:  $V_R = 0.67 \cdot V_{RRM}$ ;  $T_C = 55$  °C

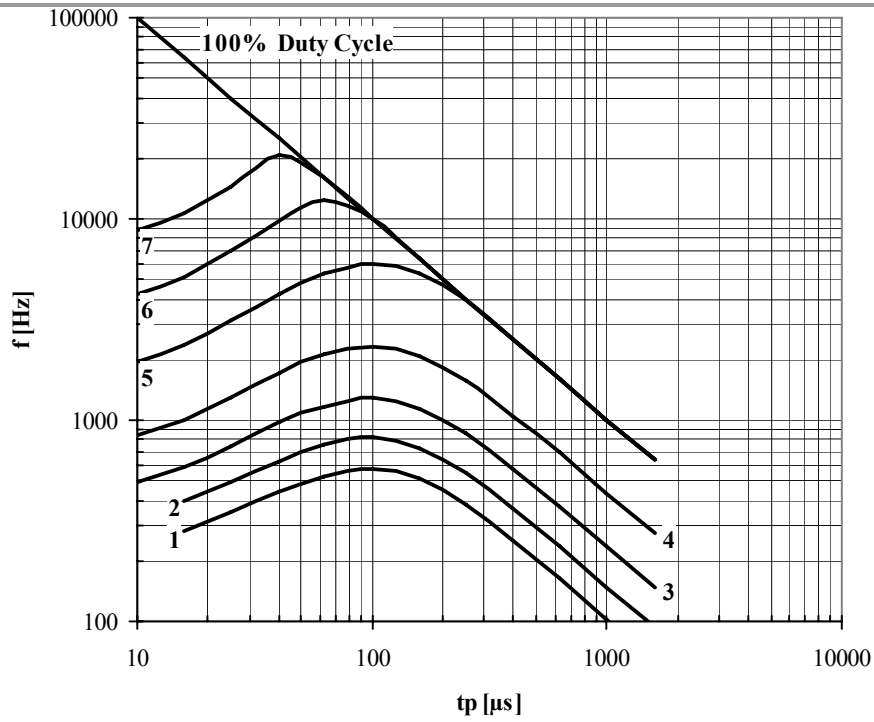

**Fig. 13** Sine wave frequency ratings

- 1 –  $I_{TM} = 5000$  A
- 2 –  $I_{TM} = 4000$  A
- 3 –  $I_{TM} = 3000$  A
- 4 –  $I_{TM} = 2000$  A
- 5 –  $I_{TM} = 1000$  A
- 6 –  $I_{TM} = 500$  A
- 7 –  $I_{TM} = 250$  A

Conditions:  $V_R = 0.67 V_{RRM}$ ;  $T_C = 80$  °C

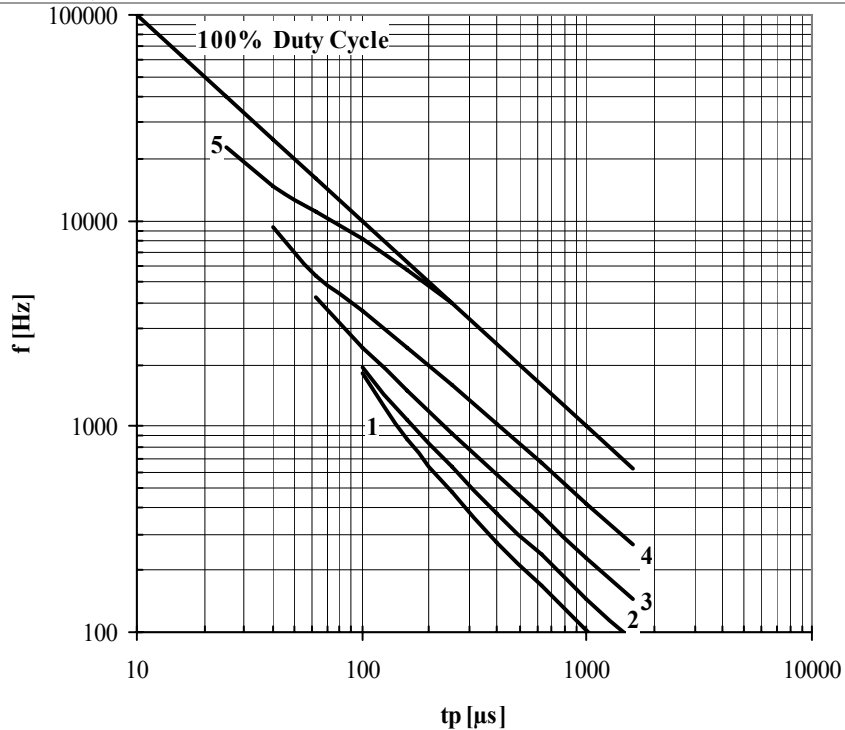

**Fig. 14** Square wave frequency ratings

- 1 –  $I_{TM} = 5000$  A
- 2 –  $I_{TM} = 4000$  A
- 3 –  $I_{TM} = 3000$  A
- 4 –  $I_{TM} = 2000$  A
- 5 –  $I_{TM} = 1000$  A
- 6 –  $I_{TM} = 500$  A

Conditions:  $V_R \leq 3 \text{ V}$ ;  $T_C = 55 \text{ }^\circ\text{C}$ ;  $di_F/dt = di_R/dt = 100 \text{ A}/\mu\text{s}$

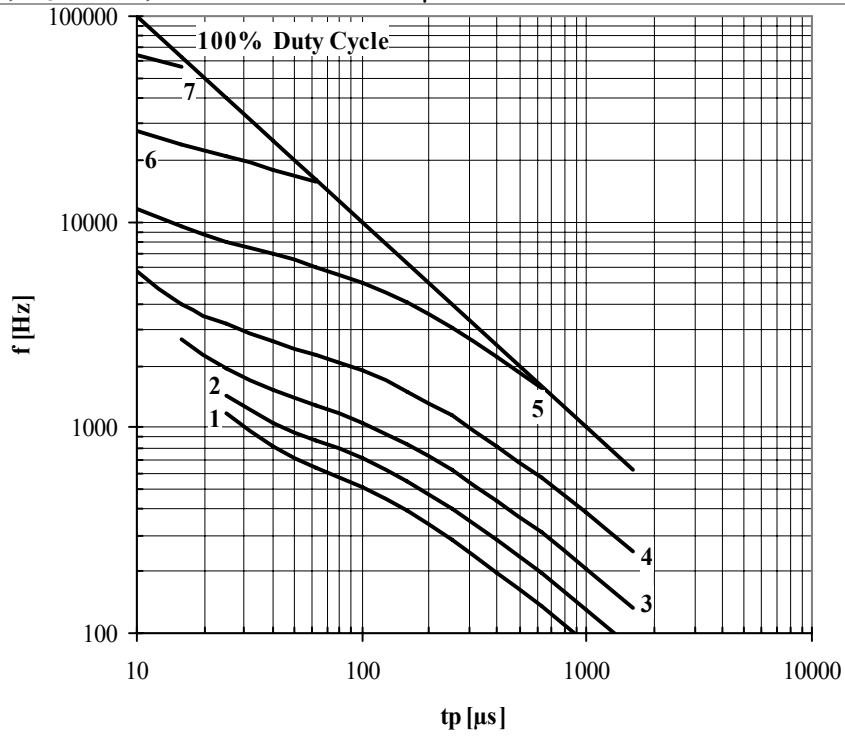

**Fig. 15** Square wave frequency ratings

- 1 -  $I_{TM} = 5000 \text{ A}$
- 2 -  $I_{TM} = 4000 \text{ A}$
- 3 -  $I_{TM} = 3000 \text{ A}$
- 4 -  $I_{TM} = 2000 \text{ A}$
- 5 -  $I_{TM} = 1000 \text{ A}$
- 6 -  $I_{TM} = 500 \text{ A}$
- 7 -  $I_{TM} = 250 \text{ A}$

Conditions:  $V_R \leq 3 \text{ V}$ ;  $T_C = 55 \text{ }^\circ\text{C}$ ;  $di_F/dt = di_R/dt = 500 \text{ A}/\mu\text{s}$

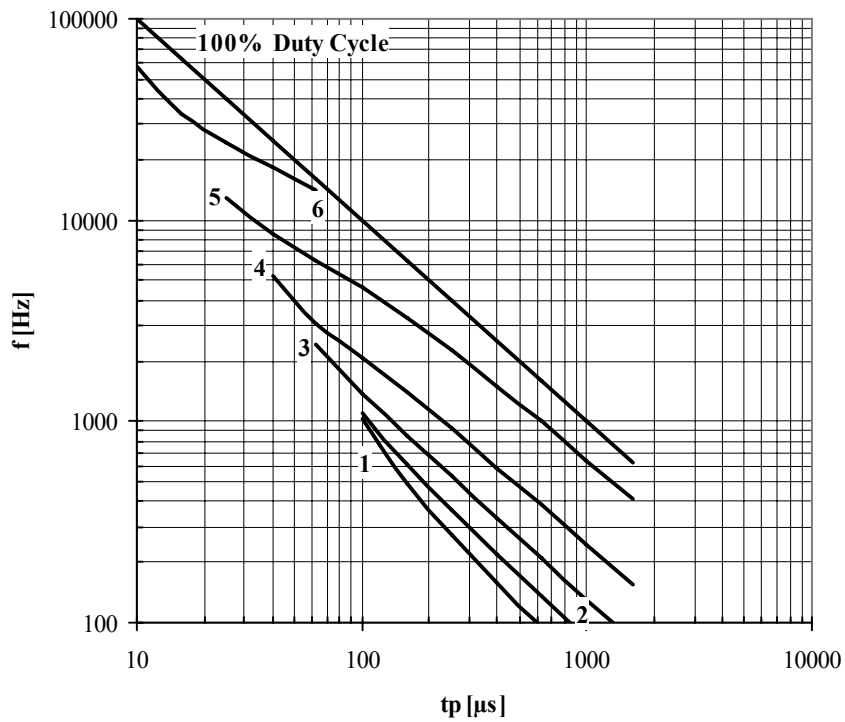

**Fig. 16** Square wave frequency ratings

- 1 –  $I_{TM} = 5000$  A
- 2 –  $I_{TM} = 4000$  A
- 3 –  $I_{TM} = 3000$  A
- 4 –  $I_{TM} = 2000$  A
- 5 –  $I_{TM} = 1000$  A
- 6 –  $I_{TM} = 500$  A
- 7 –  $I_{TM} = 250$  A

Conditions:  $V_R \leq 3$  V;  $T_C = 80$  °C;  $di_F/dt = di_R/dt = 100$  A/ $\mu$ s

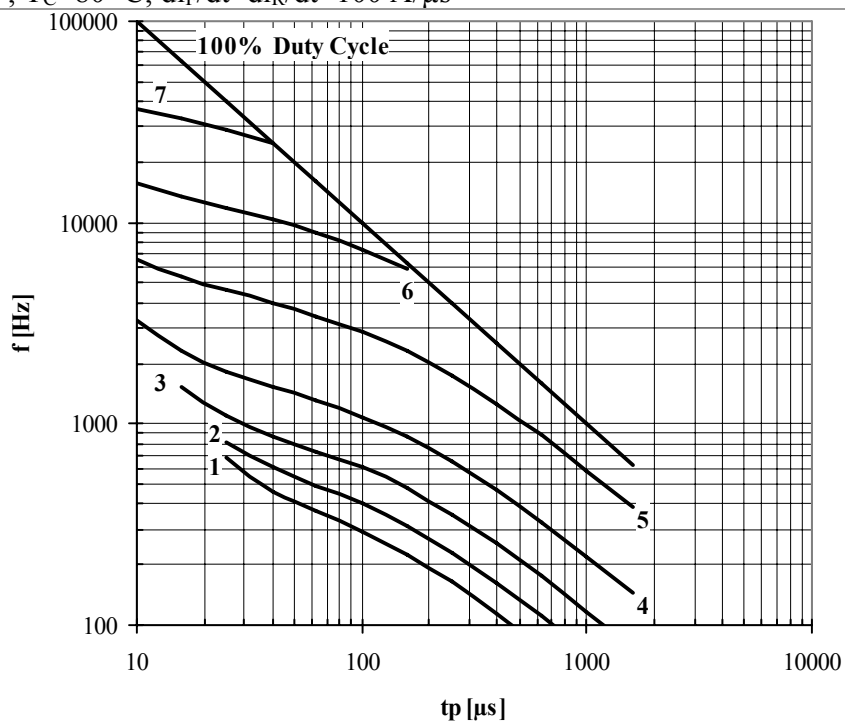

**Fig. 17** Square wave frequency ratings

- 1 –  $I_{TM} = 5000$  A
- 2 –  $I_{TM} = 4000$  A
- 3 –  $I_{TM} = 3000$  A
- 4 –  $I_{TM} = 2000$  A
- 5 –  $I_{TM} = 1000$  A
- 6 –  $I_{TM} = 500$  A
- 7 –  $I_{TM} = 250$  A

Conditions:  $V_R \leq 3$  V;  $T_C = 80$  °C;  $di_F/dt = di_R/dt = 500$  A/ $\mu$ s

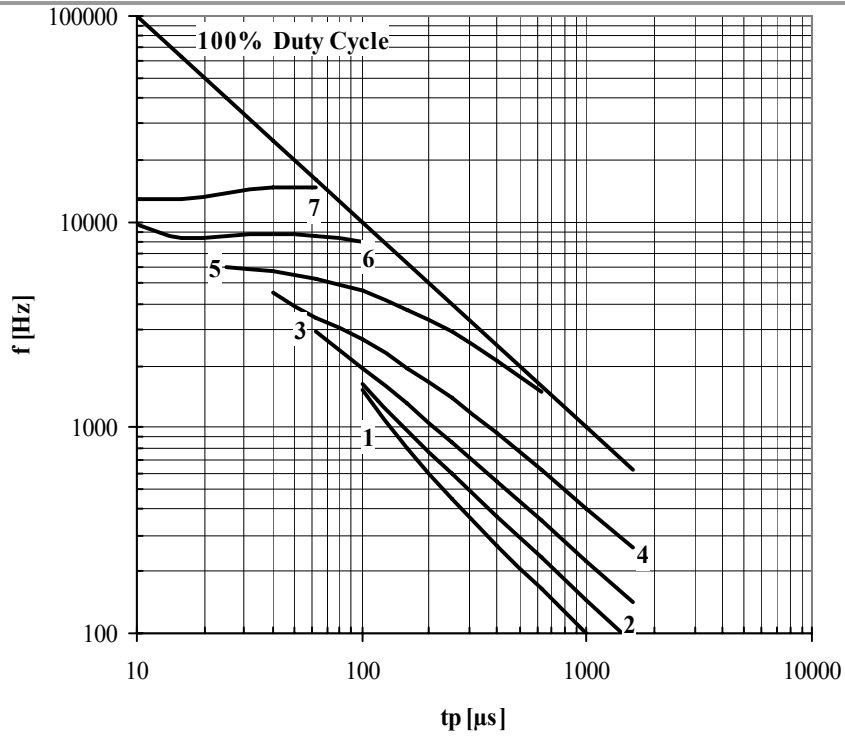

**Fig. 18** Square wave frequency ratings

- 1 –  $I_{TM} = 5000$  A
- 2 –  $I_{TM} = 4000$  A
- 3 –  $I_{TM} = 3000$  A
- 4 –  $I_{TM} = 2000$  A
- 5 –  $I_{TM} = 1000$  A
- 6 –  $I_{TM} = 500$  A
- 7 –  $I_{TM} = 250$  A

Conditions:  $V_R = 0.67 \cdot V_{RRM}$ ;  $T_C = 55$  °C;  $di_F/dt = di_R/dt = 100$  A/ $\mu$ s

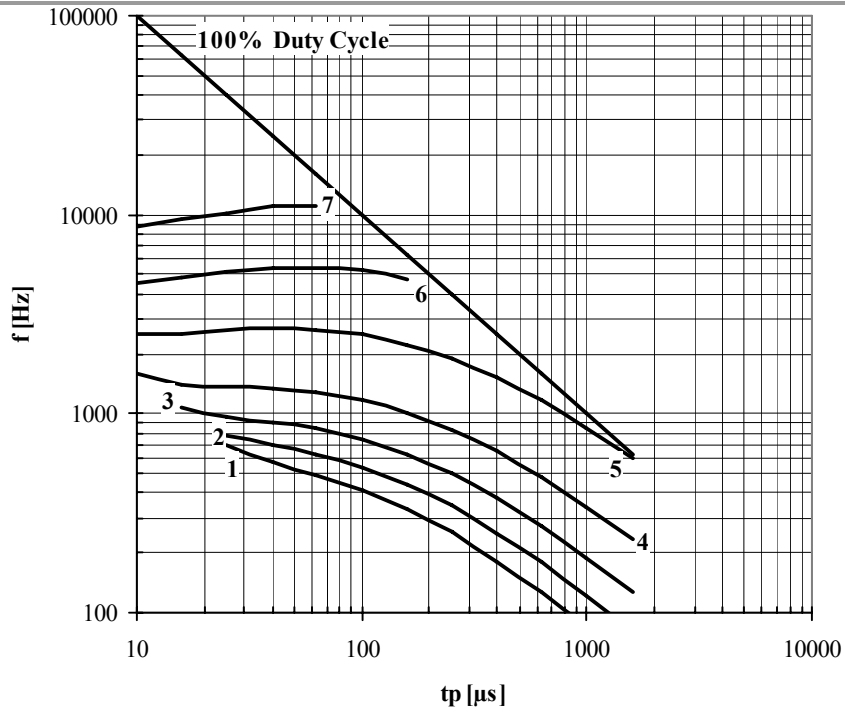

**Fig. 19** Square wave frequency ratings

- 1 –  $I_{TM} = 5000$  A
- 2 –  $I_{TM} = 4000$  A
- 3 –  $I_{TM} = 3000$  A
- 4 –  $I_{TM} = 2000$  A
- 5 –  $I_{TM} = 1000$  A
- 6 –  $I_{TM} = 500$  A
- 7 –  $I_{TM} = 250$  A

Conditions:  $V_R = 0.67 \cdot V_{RRM}$ ;  $T_C = 55$  °C;  $di_F/dt = di_R/dt = 500$  A/μs

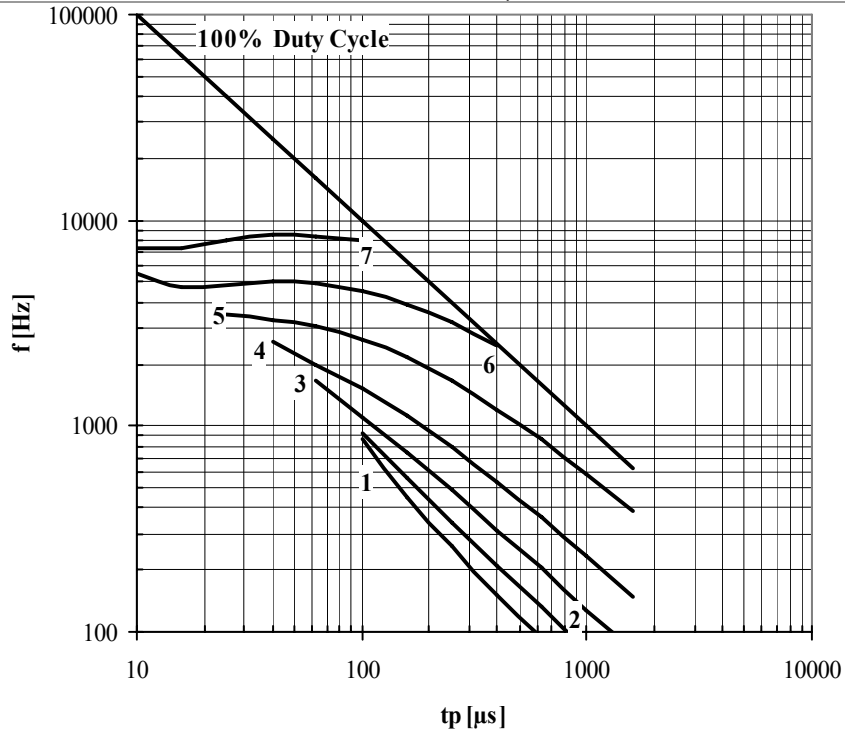

**Fig. 20** Square wave frequency ratings

- 1 –  $I_{TM} = 5000$  A
- 2 –  $I_{TM} = 4000$  A
- 3 –  $I_{TM} = 3000$  A
- 4 –  $I_{TM} = 2000$  A
- 5 –  $I_{TM} = 1000$  A
- 6 –  $I_{TM} = 500$  A
- 7 –  $I_{TM} = 250$  A

Conditions:  $V_R = 0.67 V_{RRM}$ ;  $T_C = 80$  °C;  $di_F/dt = di_R/dt = 100$  A/ $\mu$ s

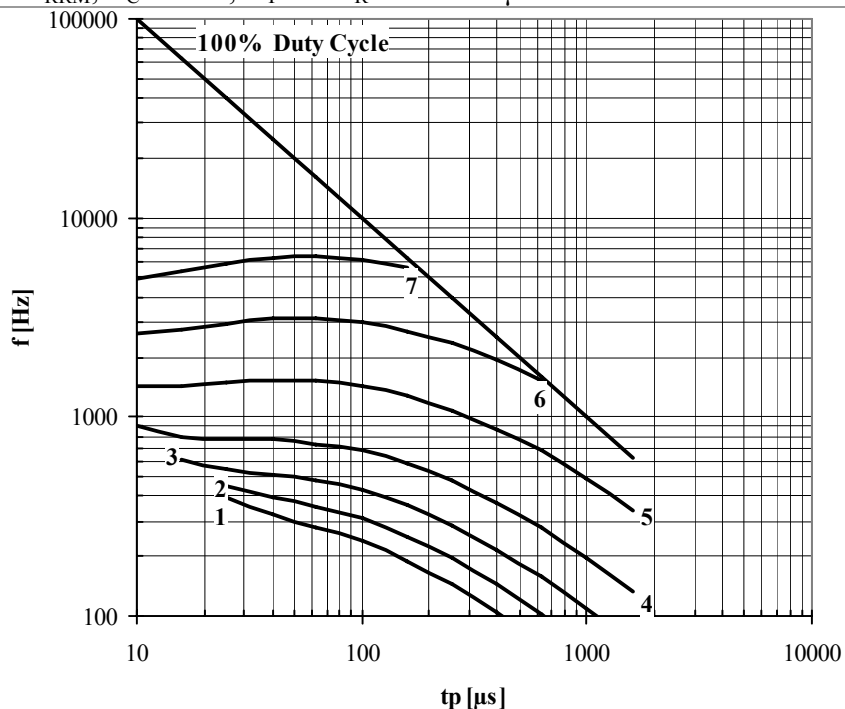

**Fig. 21** Square wave frequency ratings

- 1 –  $I_{TM} = 5000$  A
- 2 –  $I_{TM} = 4000$  A
- 3 –  $I_{TM} = 3000$  A
- 4 –  $I_{TM} = 2000$  A
- 5 –  $I_{TM} = 1000$  A
- 6 –  $I_{TM} = 500$  A
- 7 –  $I_{TM} = 250$  A

Conditions:  $V_R = 0.67 V_{RRM}$ ;  $T_C = 80$  °C;  $di_F/dt = di_R/dt = 500$  A/ $\mu$ s

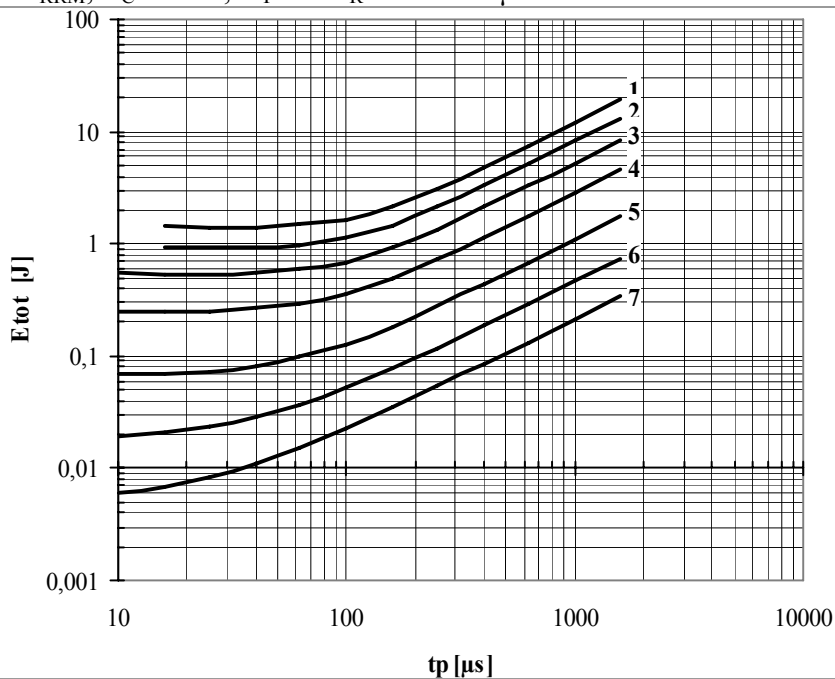

**Fig. 22** Sine wave loss energy per pulse

- 1 –  $I_{TM} = 5000$  A
- 2 –  $I_{TM} = 4000$  A
- 3 –  $I_{TM} = 3000$  A
- 4 –  $I_{TM} = 2000$  A
- 5 –  $I_{TM} = 1000$  A
- 6 –  $I_{TM} = 500$  A
- 7 –  $I_{TM} = 250$  A

Conditions:  $V_R \leq 3$  V

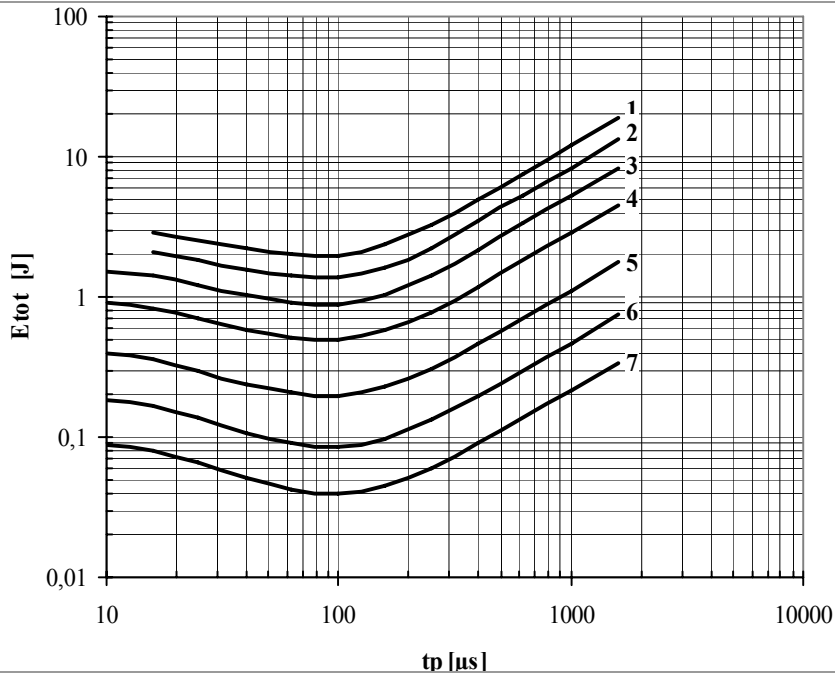

**Fig. 23** Sine wave loss energy per pulse

- 1 –  $I_{TM} = 5000$  A
- 2 –  $I_{TM} = 4000$  A
- 3 –  $I_{TM} = 3000$  A
- 4 –  $I_{TM} = 2000$  A
- 5 –  $I_{TM} = 1000$  A
- 6 –  $I_{TM} = 500$  A
- 7 –  $I_{TM} = 250$  A

Conditions:  $V_R = 0.67 \cdot V_{RRM}$

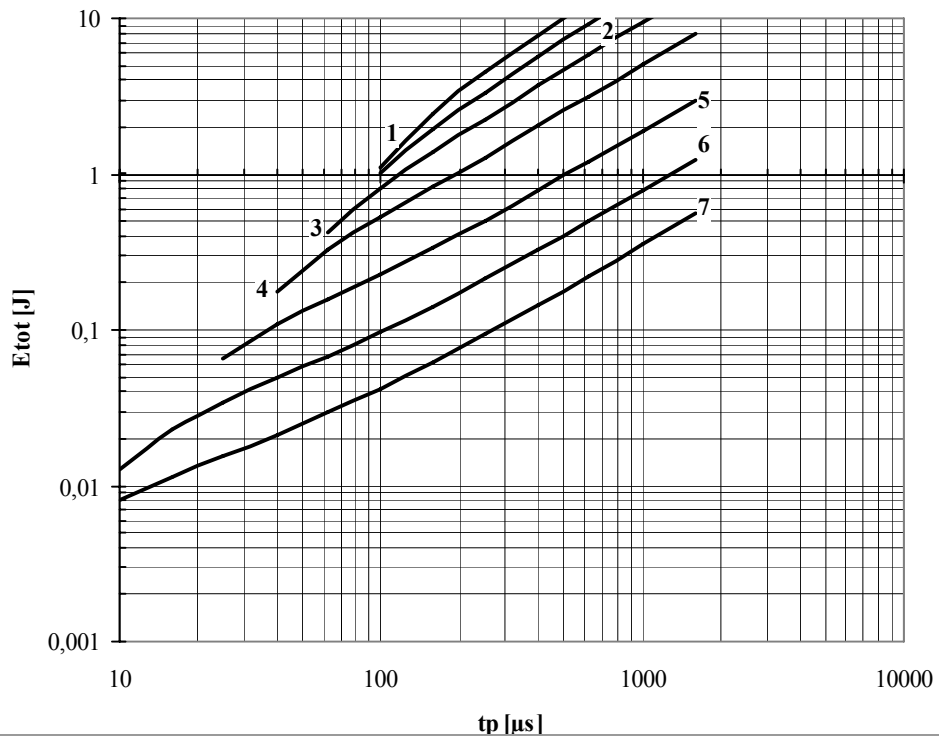

**Fig. 24** Square wave loss energy per pulse

- 1 –  $I_{TM} = 5000$  A
- 2 –  $I_{TM} = 4000$  A
- 3 –  $I_{TM} = 3000$  A
- 4 –  $I_{TM} = 2000$  A
- 5 –  $I_{TM} = 1000$  A
- 6 –  $I_{TM} = 500$  A
- 7 –  $I_{TM} = 250$  A

Conditions:  $V_R \leq 3$  V;  $di_F/dt = di_R/dt = 100$  A/ $\mu s$

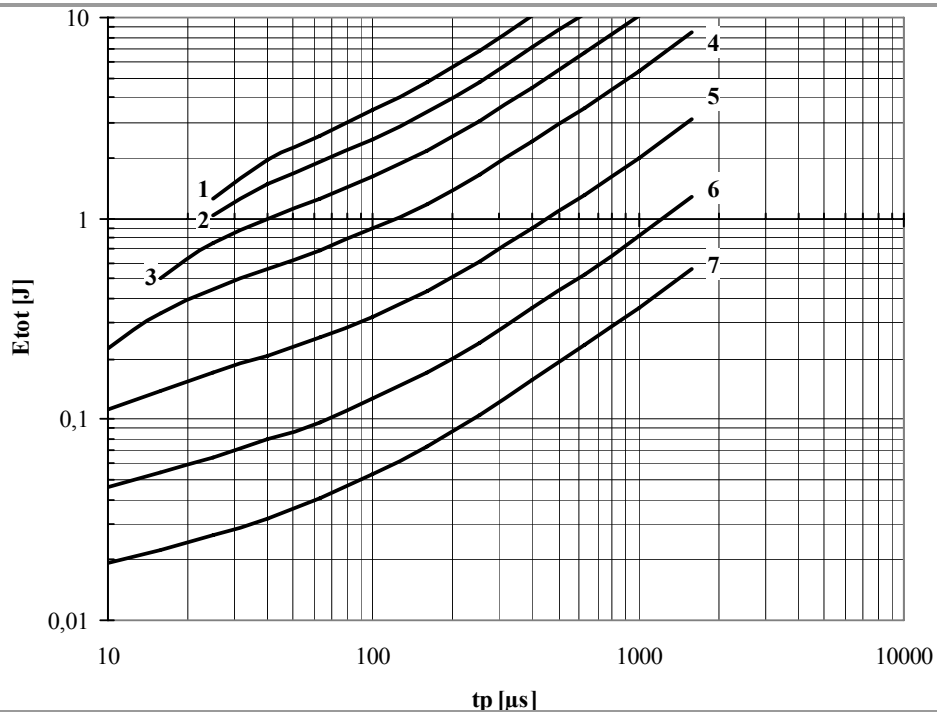

**Fig. 25** Square wave loss energy per pulse

- 1 –  $I_{TM} = 5000$  A
- 2 –  $I_{TM} = 4000$  A
- 3 –  $I_{TM} = 3000$  A
- 4 –  $I_{TM} = 2000$  A
- 5 –  $I_{TM} = 1000$  A
- 6 –  $I_{TM} = 500$  A
- 7 –  $I_{TM} = 250$  A

Conditions:  $V_R \leq 3$  V;  $di_F/dt = di_R/dt = 500$  A/ $\mu$ s

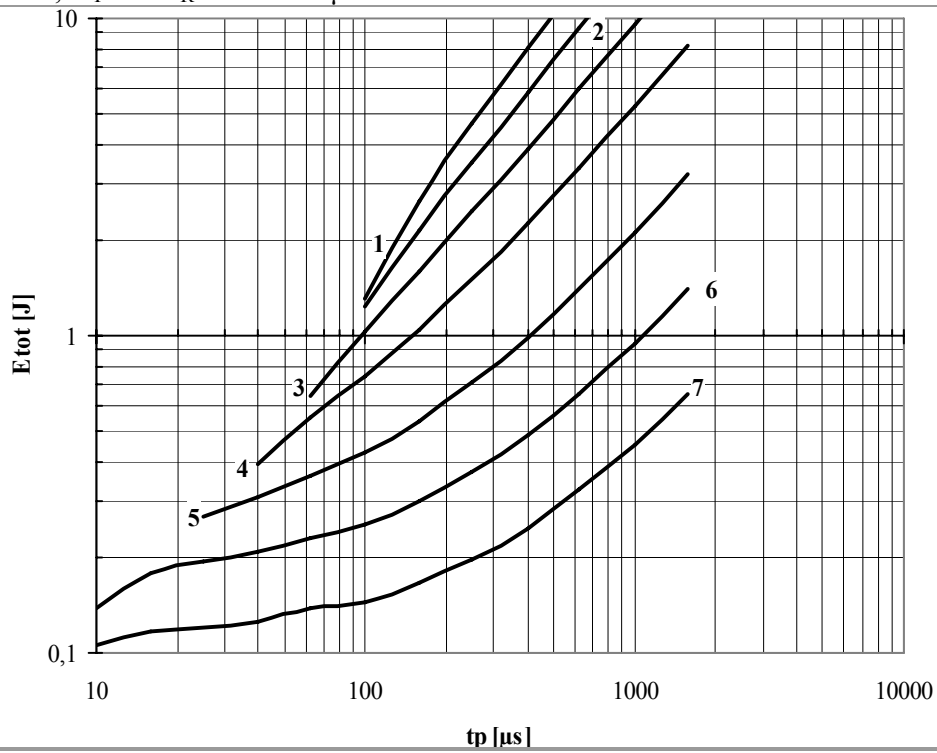

**Fig. 26** Square wave loss energy per pulse

- 1 –  $I_{TM} = 5000$  A
- 2 –  $I_{TM} = 4000$  A
- 3 –  $I_{TM} = 3000$  A
- 4 –  $I_{TM} = 2000$  A
- 5 –  $I_{TM} = 1000$  A
- 6 –  $I_{TM} = 500$  A
- 7 –  $I_{TM} = 250$  A

Conditions:  $V_R = 0.67 V_{RRM}$ ;  $di_F/dt = di_R/dt = 100$  A/ $\mu$ s

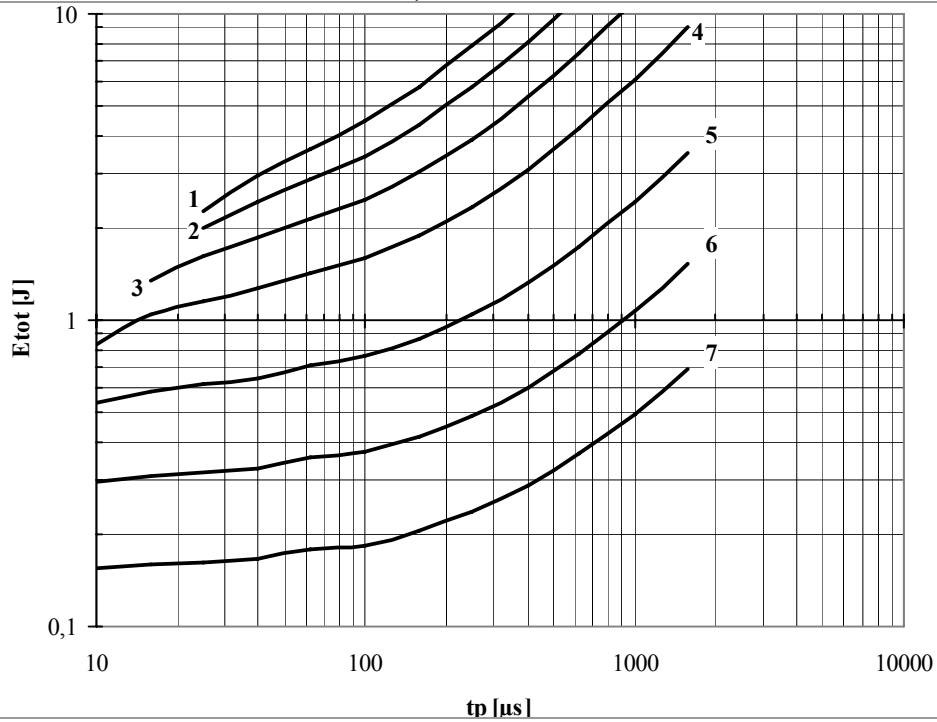

**Fig. 27** Square wave loss energy per pulse

- 1 –  $I_{TM} = 5000$  A
- 2 –  $I_{TM} = 4000$  A
- 3 –  $I_{TM} = 3000$  A
- 4 –  $I_{TM} = 2000$  A
- 5 –  $I_{TM} = 1000$  A
- 6 –  $I_{TM} = 500$  A
- 7 –  $I_{TM} = 250$  A

Conditions:  $V_R = 0.67 V_{RRM}$ ;  $di_F/dt = di_R/dt = 500$  A/ $\mu$ s

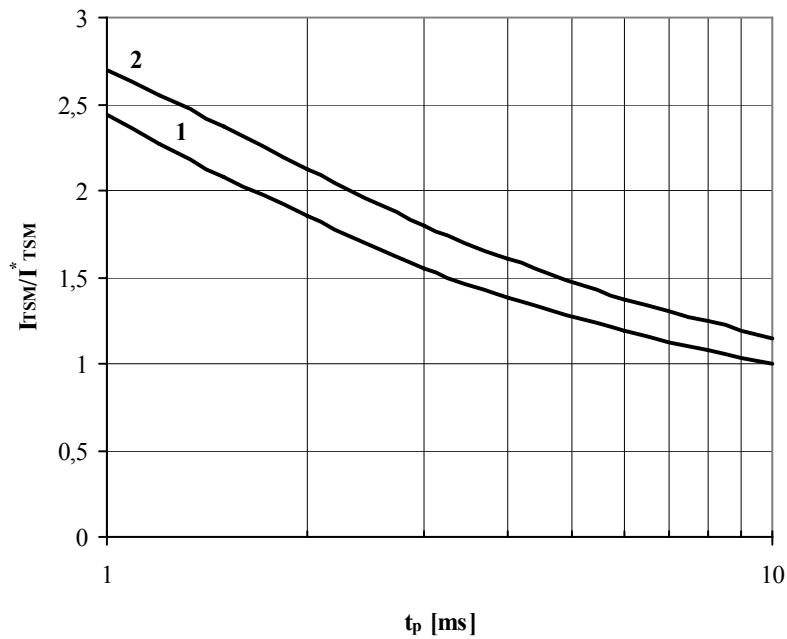

**Fig. 28** The surge current  $I_{TSM}$  vs. Duration of surge  $t_p$  for a half-sine wave  
 1 –  $T_j=125\text{ }^\circ\text{C}$   
 2 –  $T_j=25\text{ }^\circ\text{C}$

Conditions:  $V_R=0\text{ V}$  – the peak value of reverse voltage which is applied immediately after the surge current

Typical changes of  $I_{TSM}$  are normalized to the  $I_{TSM}^*$  ( $I_{TSM}^*$  – see data sheet,  $T_j=T_{j\text{ max}}$ )

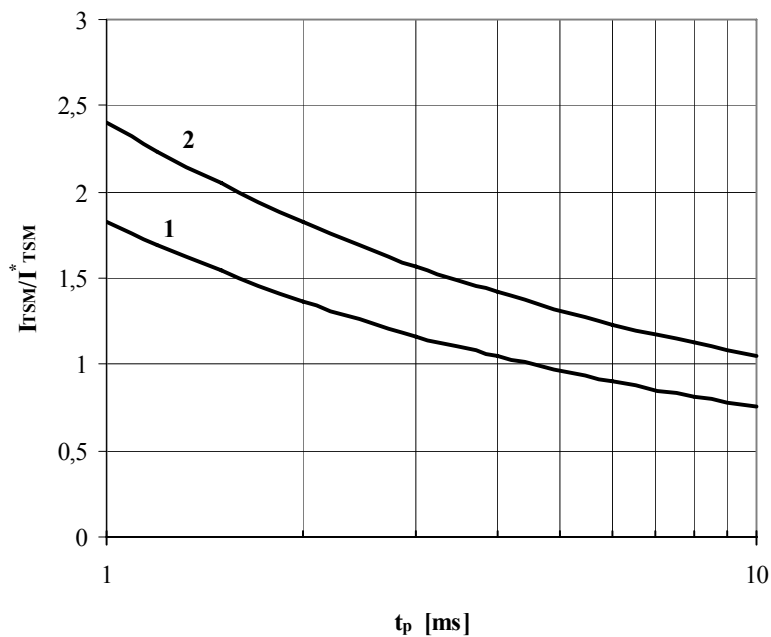

**Fig. 29** The surge current  $I_{TSM}$  vs. Duration of surge  $t_p$  for a half-sine wave  
 1 –  $T_j=125\text{ }^\circ\text{C}$   
 2 –  $T_j=25\text{ }^\circ\text{C}$

Conditions:  $V_R=0.8 \cdot V_{RRM}$  – the peak value of reverse voltage which is applied immediately after the surge current

Typical changes of  $I_{TSM}$  are normalized to the  $I_{TSM}^*$  ( $I_{TSM}^*$  – see data sheet,  $T_j=T_{j\text{ max}}$ )

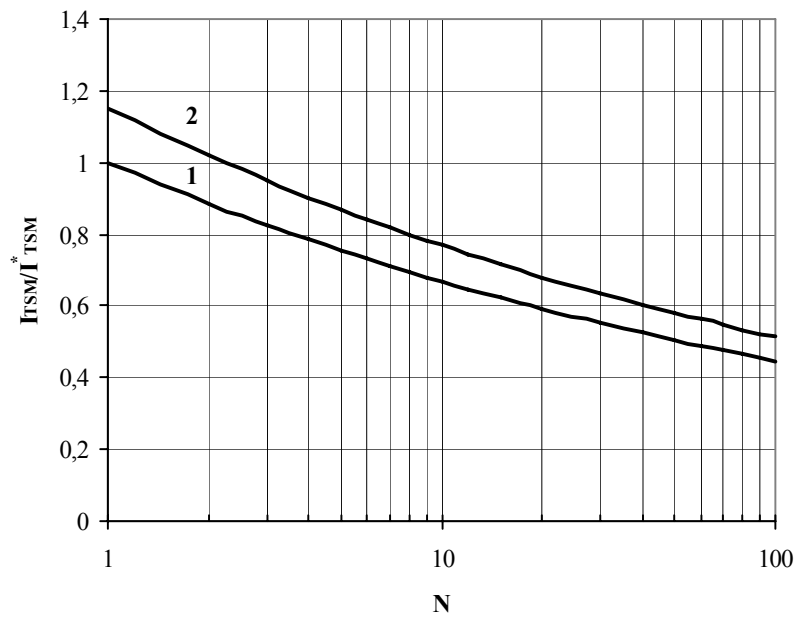

**Fig. 30** The surge current  $I_{TSM}$  vs. Number of half-sine waves at 50 Hz  
 1 –  $T_j=125^\circ\text{C}$   
 2 –  $T_j=25^\circ\text{C}$

Conditions:  $V_R=0\text{ V}$  – the peak value of reverse voltage which is applied immediately after the surge current

Typical changes of  $I_{TSM}$  are normalized to the  $I_{TSM}^*$  ( $I_{TSM}^*$  – see data sheet,  $T_j=T_{j\text{max}}$ )

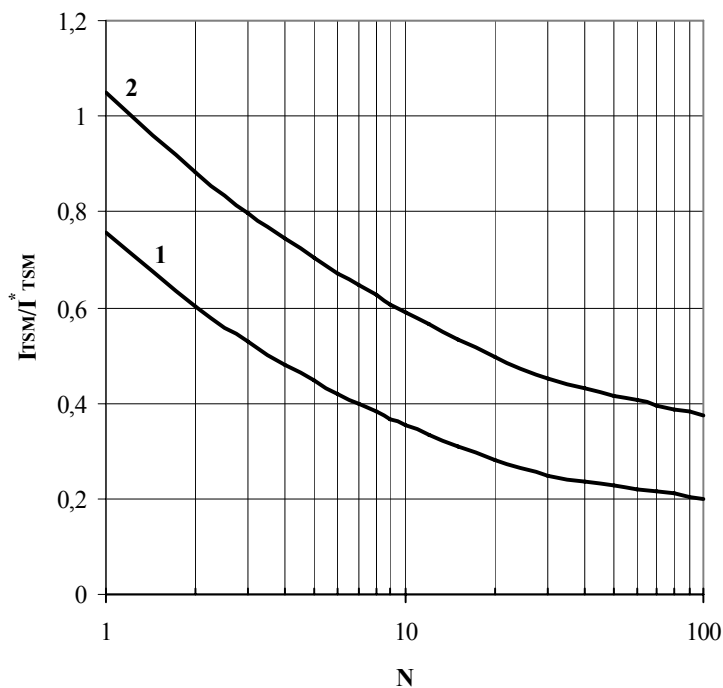

**Fig. 31** The surge current  $I_{TSM}$  vs. Number of half-sine waves at 50 Hz  
 1 –  $T_j=125^\circ\text{C}$   
 2 –  $T_j=25^\circ\text{C}$

Conditions:  $V_R=0.8 \cdot V_{RRM}$  – the peak value of reverse voltage which is applied immediately after the surge current

Typical changes of  $I_{TSM}$  are normalized to the  $I_{TSM}^*$  ( $I_{TSM}^*$  – see data sheet,  $T_j=T_{j\text{max}}$ )