

Series
TFI171C-250

Fast Stud Mounted Thyristor
Type TFI171C-250

Low turn-off time
Low reverse recovery charge
Distributed amplified gate for high di/dt

Maximum mean on-state current						I_{TAV}	250 A			
Maximum repetitive peak off-state and reverse voltage						U_{DRM}	300 ÷ 1100 V			
Turn-off time						U_{RRM}				
						t_q	8; 10; 12,5; 16 μs			
U_{DRM}, U_{RRM}, V	300	400	500	600	700	800	900	1000	1100	
Voltage code	3	4	5	6	7	8	9	10	11	
$T_{vj}, ^\circ C$	- 60 ÷ 125									

MAXIMUM ALLOWABLE RATINGS

Symbols and parameters		Units	TFI171C-250	Conditions
I_{TAV}	Mean on-state current	A	250 330	$T_c=90^\circ C$, $T_c=75^\circ C$, 180° half-sine wave, 50 Hz
I_{TRMS}	RMS on-state current	A	392	$T_c=90^\circ C$
I_{TSM}	Surge on-state current	kA	8,0 9,0	$T_{vj}=125^\circ C$ $T_{vj}=25^\circ C$
I^2t	Limiting load integral	kA^2s	320 405	$T_{vj}=125^\circ C$ $T_{vj}=25^\circ C$
U_{DRM}, U_{RRM}	Repetitive peak off-state and reverse voltage	V	300 ÷ 1100	$T_j \min \leq T_{vj} \leq T_{jM}$ 180° half-sine wave, 50 Hz Gate open
U_{DSM}, U_{RSM}	Non-repetitive peak off-state and reverse voltage	V	330 ÷ 1210	$T_j \min \leq T_{vj} \leq T_{jM}$ 180° half-sine wave $t_p=10$ ms, Single pulse Gate open
$(di_T/dt)_{crit}$	Critical rate of rise of on-state current : non - repetitive repetitive	$A/\mu s$	1600 800	$T_{vj}=125^\circ C$; $U_D=0,67 U_{DRM}$, Gate pulse : 10V, 5 Ω , 1 μ s rise time, 10 μ s
U_{RGM}	Peak reverse gate voltage	V	5	$T_j \min \leq T_{vj} \leq T_{jM}$
T_{stg}	Storage temperature	$^\circ C$	-60 ÷ 80	
T_{vj}	Junction temperature	$^\circ C$	-60 ÷ 125	

CHARACTERISTICS

U_{TM}	Peak on-state voltage	V	2,1	$T_{vj}=25^\circ C$, $I_{TM}=3,14 I_{TAV}$
$U_{T(TO)}$	Threshold voltage	V	1,35	$T_{vj}=125^\circ C$
R_T	On-state slope resistance	$m\Omega$	0,8	$1,57 I_{TAV} < I_T < 4,71 I_{TAV}$
I_{DRM} I_{RRM}	Repetitive peak off-state and reverse current	mA	50 50	$T_{vj}=125^\circ C$, $U_D = U_{DRM}$ $U_R = U_{RRM}$

CHARACTERISTICS

Symbols and parameters		Units	TFI171C-250	Conditions
I_L	Latching current	A	5	$T_{vj}=25^{\circ}\text{C}, U_D=12\text{V}$ Gate pulse : 10V, 5 Ω , 1 μs rise time, 10 μs
I_H	Holding current	A	0,5	$T_{vj}=25^{\circ}\text{C}, U_D=12\text{V}$, Gate open
U_{GT}	Gate trigger direct voltage	V	2,5 5,0	$T_{vj}=25^{\circ}\text{C}$, $T_{vj}=-60^{\circ}\text{C}$ $U_D=12\text{V}$
I_{GT}	Gate trigger direct current	A	0,3 0,85	$T_{vj}=25^{\circ}\text{C}$, $T_{vj}=-60^{\circ}\text{C}$
U_{GD}	Gate non-trigger direct voltage	V	0,25	$T_{vj}=125^{\circ}\text{C}$, $U_D = 0,67 U_{DRM}$
I_{GD}	Gate non-trigger direct current	mA	10	Direct gate current
t_{gd}	Delay time	μs	1,6	$T_{vj}=25^{\circ}\text{C}, U_D=500\text{V}$ $I_{TM} = 250\text{ A}$
t_{gt}	Turn-on time	μs	2,5	Gate pulse : 10V, 5 Ω , 1 μs rise time, 10 μs
t_q	Turn-off time	μs	8÷16 10÷20	$T_{vj}=125^{\circ}\text{C}$, $I_{TM}=250\text{ A}$ $di_R/dt = 10\text{ A}/\mu\text{s}$, $U_R=100\text{V}$ $U_D = 0,67 U_{DRM}$ $du_D/dt=50\text{ V}/\mu\text{s}$ $du_D/dt=200\text{ V}/\mu\text{s}$
Q_{rr}	Recovered charge	μC	100	$T_{vj}=125^{\circ}\text{C}$, $I_{TM}=250\text{ A}$ $di_R/dt = 50\text{ A}/\mu\text{s}$, $U_R=100\text{V}$
t_{rr}	Reverse recovery time	μs	3,1	
I_{RM}	Peak reverse recovery current	A	70	
$(du_D/dt)_{crit}$	Critical rate of rise of off-state voltage	V/ μs	500 1000	$T_{vj}=125^{\circ}\text{C}$, $U_D = 0,67 U_{DRM}$ Gate open
R_{thjc}	Thermal resistance junction to case	$^{\circ}\text{C}/\text{W}$	0,075	Direct current

ORDERING

	TFI	171	C	250	10	7	8	3	
	1	2	3	4	5	6	7	8	

1. Fast thyristor with interdigitated gate structure.
2. Design version.
3. Flat-base (anode).
4. Mean on-state current, A.
5. Voltage code (10=1000V).
6. Critical rate of rise of off-state voltage (6 $\geq 500\text{ V}/\mu\text{s}$, 7 $\geq 1000\text{ V}/\mu\text{s}$)
7. Group of turn-off time ($du_D/dt=50\text{ V}/\mu\text{s}$, 7 $\leq 16\ \mu\text{s}$, 8 $\leq 12,5\ \mu\text{s}$, A4 $\leq 10\ \mu\text{s}$, 9 $\leq 8\ \mu\text{s}$)
8. Group of turn-on time (3 $\leq 2,5\ \mu\text{s}$).

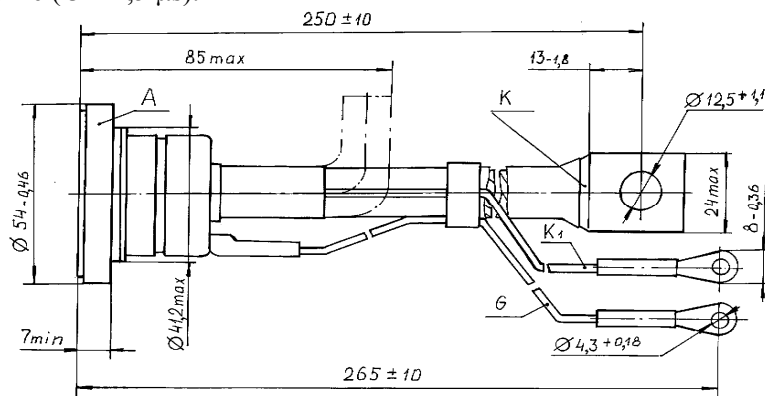

Mounting force : 5 ÷ 7 kN
Weight : 500 grams

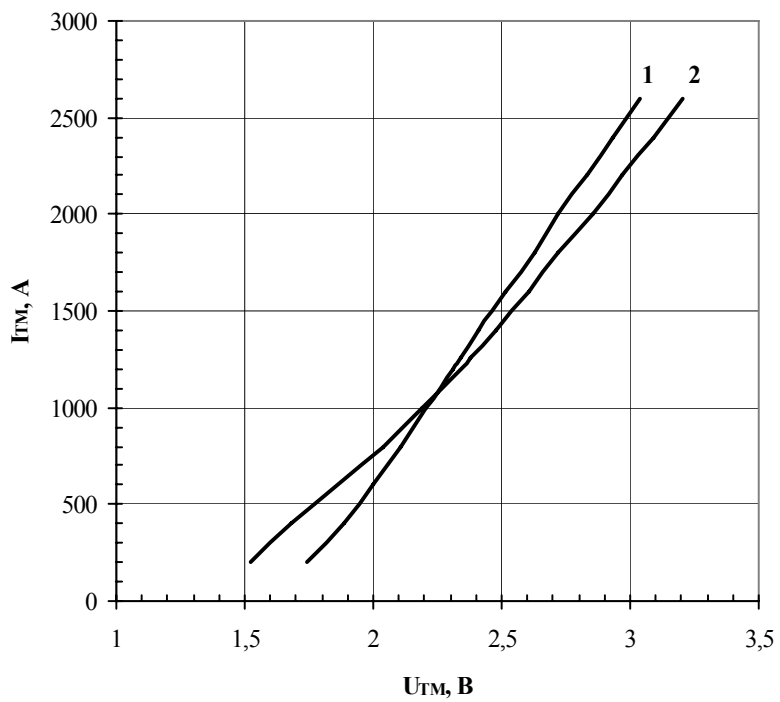
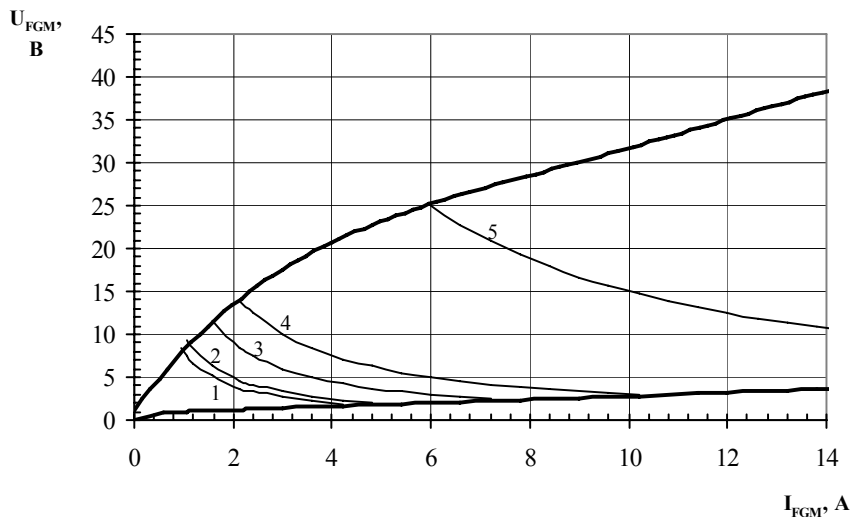

Fig. 1 On-state characteristics of Limit device

1 – $T_j = 25\text{ °C}$
 2 – $T_j = 125\text{ °C}$



Maximum peak gate power loss

Position	On-Off time ratio	Gate pulse length, ms	Gate Pulse Power, W
1	1	DC	8
2	2	10	10
3	20	1	18
4	40	0.5	30
5	200	0.1	150

Fig. 2 Gate characteristics

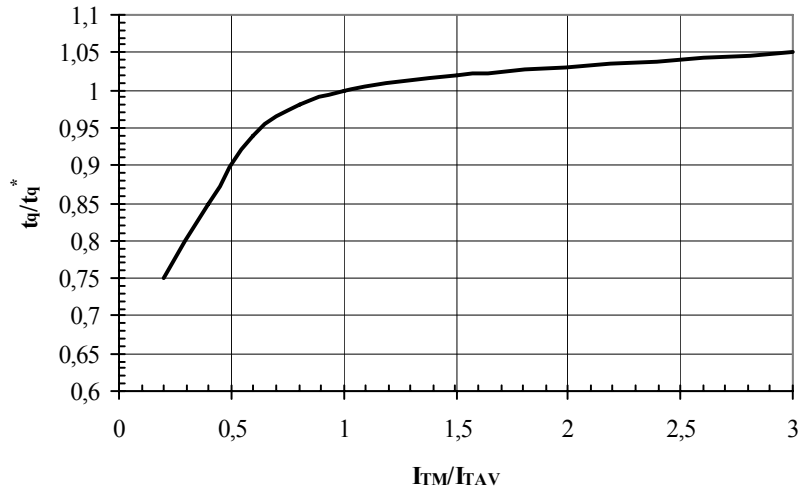

Fig. 3 Turn-off time t_q vs. On-state peak current I_{TM}

Conditions: $T_j=T_{j\max}$; $di_R/dt=10\text{ A}/\mu\text{s}$; $V_R=100\text{ V}$; $dv_D/dt=50\text{ V}/\mu\text{s}$; $V_D=0.67\cdot V_{DRM}$
 Typical changes of t_q are normalized to the t_q^* (t_q^* – see data sheet, $dv_D/dt=50\text{ V}/\mu\text{s}$)

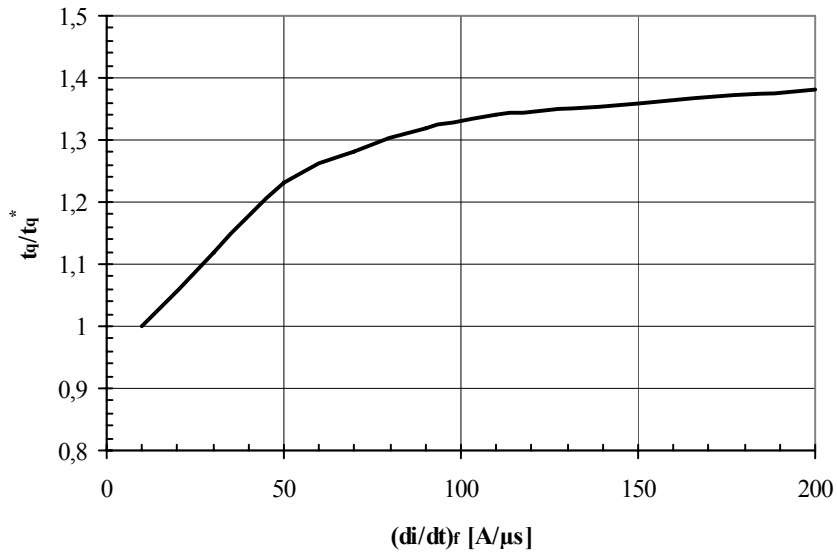

Fig. 4 Turn-off time t_q vs. Rate of fall of on-state current di_R/dt

Conditions: $T_j=T_{j\max}$; $I_{TM}=I_{TAV}$; $V_R=100\text{ V}$; $dv_D/dt=50\text{ V}/\mu\text{s}$; $V_D=0.67\cdot V_{DRM}$
 Typical changes of t_q are normalized to the t_q^* (t_q^* – see data sheet, $dv_D/dt=50\text{ V}/\mu\text{s}$)

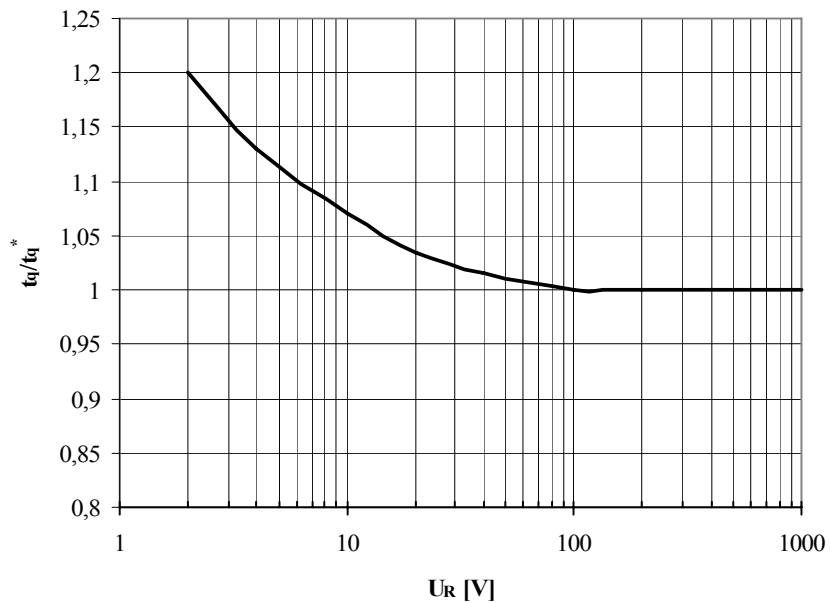

Fig. 5 Turn-off time t_q vs. Reverse voltage V_R

Conditions: $T_j=T_{j\max}$; $I_{TM}=I_{TAV}$; $di_R/dt=10\text{ A}/\mu\text{s}$; $dv_D/dt=50\text{ V}/\mu\text{s}$; $V_D=0.67\cdot V_{DRM}$
 Typical changes of t_q are normalized to the t_q^* (t_q^* – see data sheet, $dv_D/dt=50\text{ V}/\mu\text{s}$)

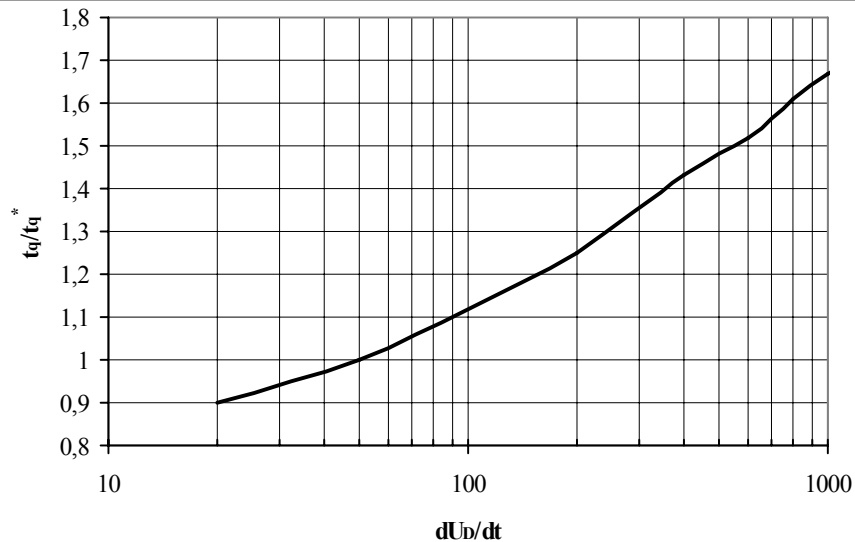

Fig. 6 Turn-off time t_q vs. Rate of rise of commutating voltage dv_D/dt

Conditions: $T_j=T_{j\max}$; $I_{TM}=I_{TAV}$; $di_R/dt=10\text{ A}/\mu\text{s}$; $V_R=100\text{ V}$; $V_D=0.67\cdot V_{DRM}$
 Typical changes of t_q are normalized to the t_q^* (t_q^* – see data sheet, $dv_D/dt=50\text{ V}/\mu\text{s}$)

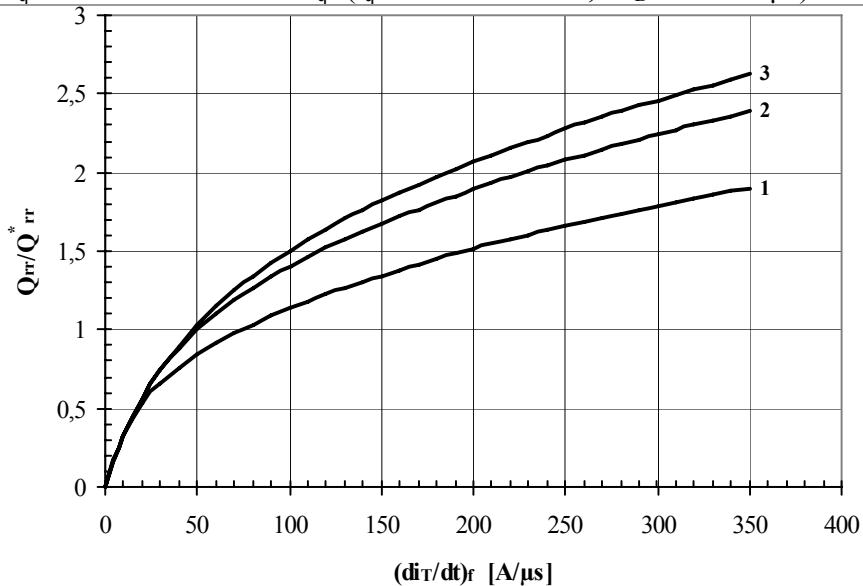

Fig. 7 Reverse recovery charge Q_{rr} , vs. Rate of fall of on-state current di_R/dt

- 1 – $I_{TM} = 0.5 \cdot I_{TAV}$
- 2 – $I_{TM} = I_{TAV}$,
- 3 – $I_{TM} = 1.5 \cdot I_{TAV}$

Conditions: $T_j=T_{j\max}$; $V_R=100\text{ V}$

Typical changes of Q_{rr} are normalized to the Q_{rr}^* (Q_{rr}^* – see data sheet)

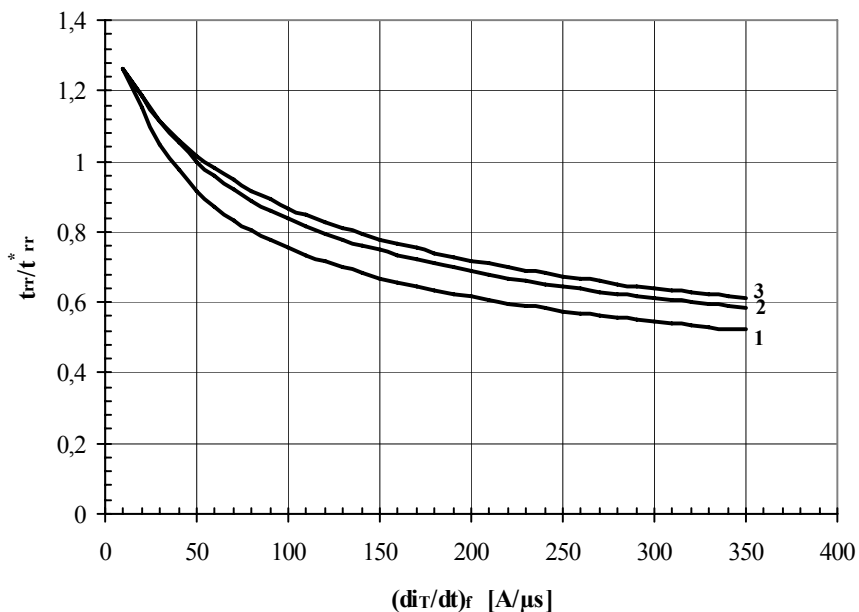

Fig. 8 Reverse recovery time t_{rr} vs. Rate of fall of on-state current di_R/dt

1 – $I_{TM} = 0.5 \cdot I_{TAV}$

2 – $I_{TM} = I_{TAV}$,

3 – $I_{TM} = 1.5 \cdot I_{TAV}$

Conditions: $T_j = T_{j \max}$; $V_R = 100$ V

Typical changes of t_{rr} are normalized to the t_{rr}^* (t_{rr}^* – see data sheet)

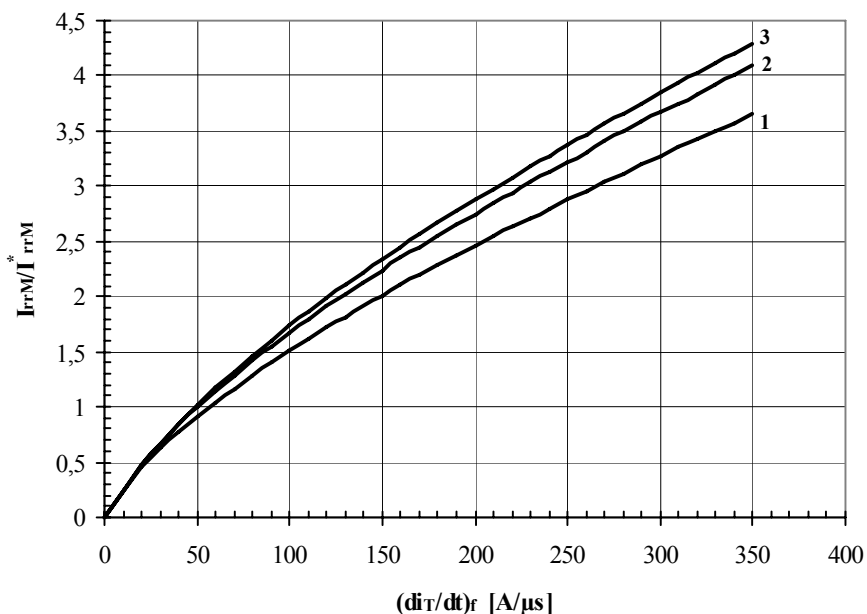

Fig. 9 Peak reverse recovery current I_{rrM} vs. Rate of fall of on-state current di_R/dt

1 – $I_{TM} = 0.5 \cdot I_{TAV}$

2 – $I_{TM} = I_{TAV}$,

3 – $I_{TM} = 1.5 \cdot I_{TAV}$

Conditions: $T_j = T_{j \max}$; $V_R = 100$ V

Typical changes of I_{rrM} are normalized to the I_{rrM}^* (I_{rrM}^* – see data sheet)

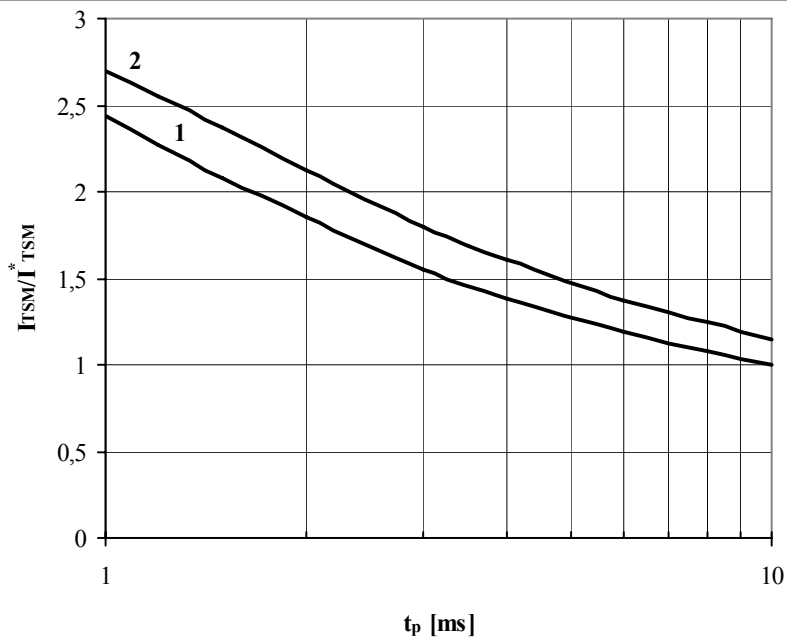

Fig. 10 The surge current I_{TSM} vs. Duration of surge t_p for a half-sine wave
 1 – $T_j=125\text{ °C}$
 2 – $T_j=25\text{ °C}$

Conditions: $V_R=0\text{ V}$ – the peak value of reverse voltage which is applied immediately after the surge current

Typical changes of I_{TSM} are normalized to the I_{TSM}^* (I_{TSM}^* – see data sheet, $T_j=T_{j\text{ max}}$)

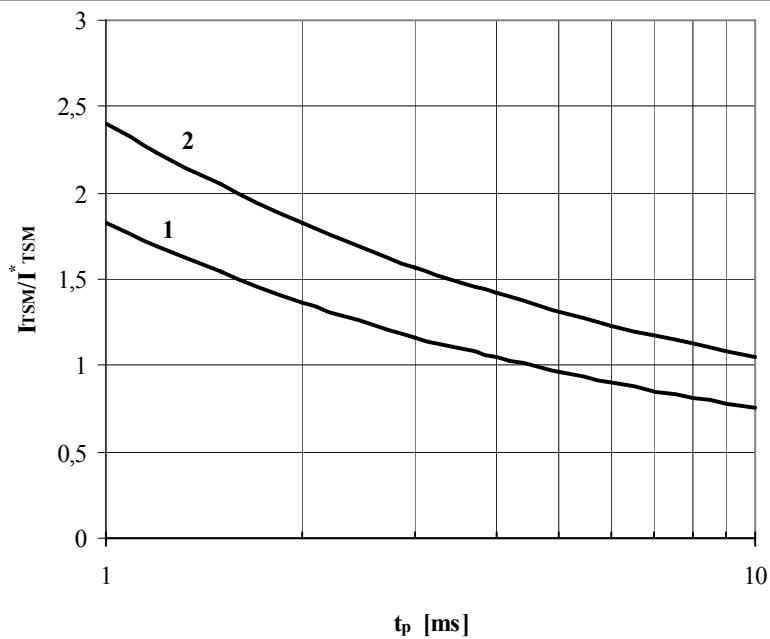

Fig. 11 The surge current I_{TSM} vs. Duration of surge t_p for a half-sine wave
 1 – $T_j=125\text{ °C}$
 2 – $T_j=25\text{ °C}$

Conditions: $V_R=0.8 \cdot V_{RRM}$ – the peak value of reverse voltage which is applied immediately after the surge current

Typical changes of I_{TSM} are normalized to the I_{TSM}^* (I_{TSM}^* – see data sheet, $T_j=T_{j\text{ max}}$)

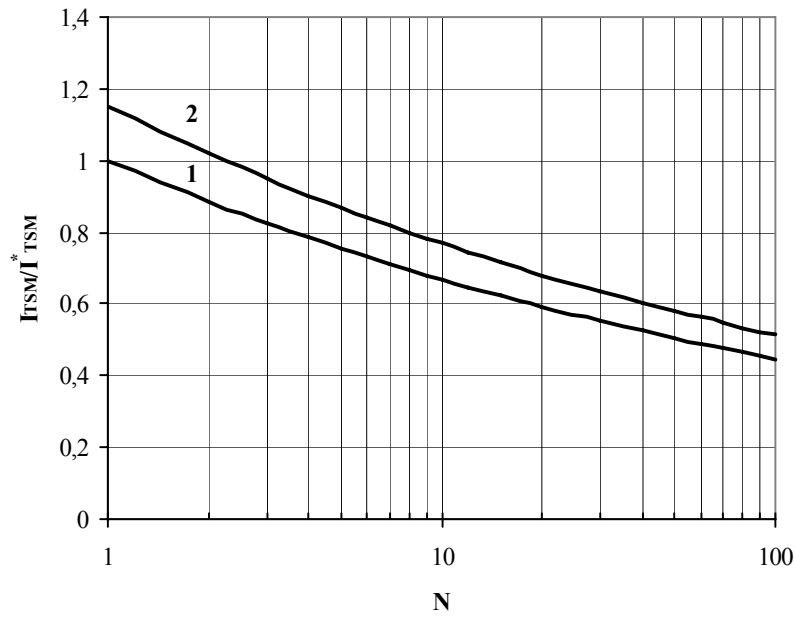

Fig. 12 The surge current I_{TSM} vs. Number of half-sine waves at 50 Hz
 1 – $T_j=125\text{ }^\circ\text{C}$
 2 – $T_j=25\text{ }^\circ\text{C}$

Conditions: $V_R=0\text{ V}$ – the peak value of reverse voltage which is applied immediately after the surge current

Typical changes of I_{TSM} are normalized to the I_{TSM}^* (I_{TSM}^* – see data sheet, $T_j=T_{j\text{ max}}$)

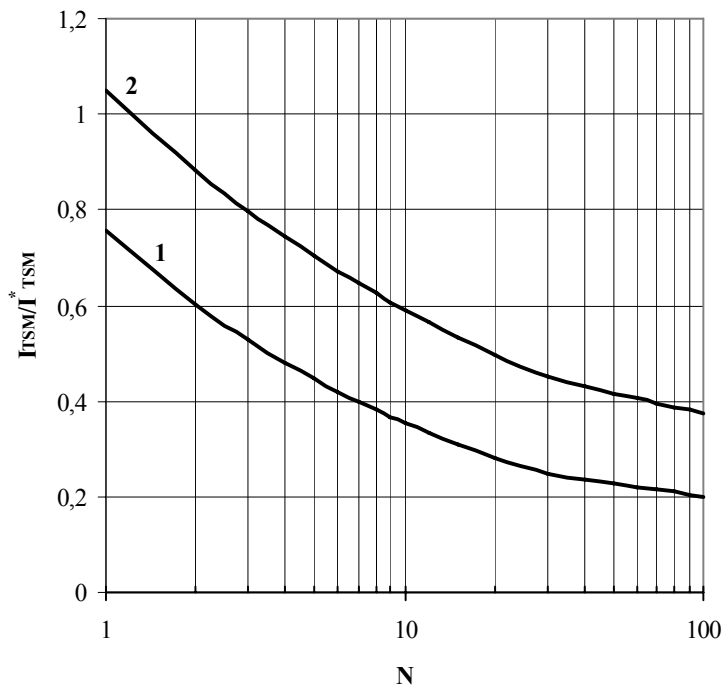

Fig. 13 The surge current I_{TSM} vs. Number of half-sine waves at 50 Hz
 1 – $T_j=125\text{ }^\circ\text{C}$
 2 – $T_j=25\text{ }^\circ\text{C}$

Conditions: $V_R=0.8 \cdot V_{RRM}$ – the peak value of reverse voltage which is applied immediately after the surge current

Typical changes of I_{TSM} are normalized to the I_{TSM}^* (I_{TSM}^* – see data sheet, $T_j=T_{j\text{ max}}$)