

Series
TFI133-400

High Frequency Inverter grade Capsule Thyristor Type TFI133-400

Low turn-off time
Low reverse recovery charge
Distributed amplified gate for high di/dt

Maximum mean on-state current						I_{TAV}	400 A			
Maximum repetitive peak off-state and reverse voltage						U_{DRM}	300 ÷ 1100 V			
Turn-off time						U_{RRM}				
						t_q	8; 10; 12,5; 16 μs			
U_{DRM}, U_{RRM}, V	300	400	500	600	700	800	900	1000	1100	
Voltage code	3	4	5	6	7	8	9	10	11	
$T_{vj}, ^\circ C$	- 60 ÷ 125									

MAXIMUM ALLOWABLE RATINGS

Symbols and parameters		Units	TFI133-400	Conditions
I_{TAV}	Mean on-state current	A	400 670	$T_c=90^\circ C$, $T_c=55^\circ C$, 180° half-sine wave, 50 Hz
I_{TRMS}	RMS on-state current	A	628	$T_c=90^\circ C$
I_{TSM}	Surge on-state current	kA	8,0 9,0	$T_{vj}=125^\circ C$ $T_{vj}=25^\circ C$
I^2t	Limiting load integral	kA^2s	320 405	$T_{vj}=125^\circ C$ $T_{vj}=25^\circ C$
U_{DRM}, U_{RRM}	Repetitive peak off-state and reverse voltage	V	300 ÷ 1100	$T_j \min \leq T_{vj} \leq T_{jM}$ 180° half-sine wave, 50 Hz Gate open
U_{DSM}, U_{RSM}	Non-repetitive peak off-state and reverse voltage	V	330 ÷ 1210	$T_j \min \leq T_{vj} \leq T_{jM}$ 180° half-sine wave $t_p=10$ ms, Single pulse Gate open
$(di_T/dt)_{crit}$	Critical rate of rise of on-state current : non - repetitive repetitive	A/ μ s	1600 1000	$T_{vj}=125^\circ C$; $U_D=0,67 U_{DRM}$, Gate pulse : 10V, 5 Ω , 1 μ s rise time, 10 μ s
U_{RGM}	Peak reverse gate voltage	V	5	$T_j \min \leq T_{vj} \leq T_{jM}$
T_{stg}	Storage temperature	$^\circ C$	-60 ÷ 80	
T_{vj}	Junction temperature	$^\circ C$	-60 ÷ 125	

CHARACTERISTICS

U_{TM}	Peak on-state voltage	V	2,4	$T_{vj}=25^\circ C$, $I_{TM}=3,14 I_{TAV}$
$U_{T(TO)}$	Threshold voltage	V	1,4	$T_{vj}=125^\circ C$
R_T	On-state slope resistance	m Ω	0,72	1,57 $I_{TAV} < I_T < 4,71 I_{TAV}$
I_{DRM} I_{RRM}	Repetitive peak off-state and reverse current	mA	50 50	$T_{vj}=125^\circ C$, $U_D = U_{DRM}$ $U_R = U_{RRM}$

CHARACTERISTICS

Symbols and parameters		Units	TFI133-400	Conditions
I_L	Latching current	A	5	$T_{vj}=25^{\circ}\text{C}, U_D=12\text{V}$ Gate pulse : 10V, 5 Ω , 1 μs rise time, 10 μs
I_H	Holding current	A	0,5	$T_{vj}=25^{\circ}\text{C}, U_D=12\text{V}$, Gate open
U_{GT}	Gate trigger direct voltage	V	2,5 5,0	$T_{vj}=25^{\circ}\text{C}$, $T_{vj}=-60^{\circ}\text{C}$ $U_D=12\text{V}$
I_{GT}	Gate trigger direct current	A	0,3 0,85	$T_{vj}=25^{\circ}\text{C}$, $T_{vj}=-60^{\circ}\text{C}$
U_{GD}	Gate non-trigger direct voltage	V	0,25	$T_{vj}=125^{\circ}\text{C}, U_D = 0,67 U_{DRM}$
I_{GD}	Gate non-trigger direct current	mA	10	Direct gate current
t_{gd}	Delay time	μs	1,6	$T_{vj}=25^{\circ}\text{C}, U_D=500\text{V}$ $I_{TM} = 400\text{ A}$
t_{gt}	Turn-on time	μs	2,5	Gate pulse : 10V, 5 Ω , 1 μs rise time, 10 μs
t_q	Turn-off time	μs	8 \div 16 10 \div 20	$T_{vj}=125^{\circ}\text{C}, I_{TM}=400\text{ A}$ $di_R/dt = 10\text{ A}/\mu\text{s}, U_R=100\text{V}$ $U_D = 0,67 U_{DRM}$ $du_D/dt=50\text{ V}/\mu\text{s}$ $du_D/dt=200\text{ V}/\mu\text{s}$
Q_{rr}	Recovered charge	μC	100	$T_{vj}=125^{\circ}\text{C}, I_{TM}=400\text{ A}$ $di_R/dt = 50\text{ A}/\mu\text{s}, U_R=100\text{V}$
t_{rr}	Reverse recovery time	μs	3,1	
I_{rrM}	Peak reverse recovery current	A	70	
$(du_D/dt)_{crit}$	Critical rate of rise of off-state voltage	V/ μs	500 1000	$T_{vj}=125^{\circ}\text{C}, U_D = 0,67 U_{DRM}$ Gate open
R_{thjc}	Thermal resistance junction to case	$^{\circ}\text{C}/\text{W}$	0,04	Direct current, double side cooled

ORDERING

	TFI	133	400	10	7	8	3	
	1	2	3	4	5	6	7	

1. Fast thyristor with interdigitated gate structure.
2. Design version.
3. Mean on-state current, A.
4. Voltage code (10=1000V).
5. Critical rate of rise of off-state voltage (6 \geq 500 V/ μs , 7 \geq 1000 V/ μs)
6. Group of turn-off time ($du_D/dt=50\text{ V}/\mu\text{s}$, 7 \leq 16 μs , 8 \leq 12,5 μs , A4 \leq 10 μs , 9 \leq 8 μs)
7. Group of turn-on time (3 \leq 2,5 μs).

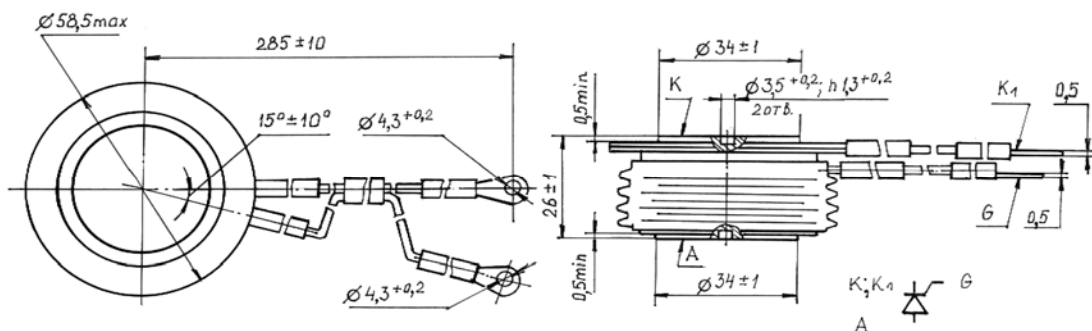

Mounting force : 10 \div 15 kN

Weight : 250 grams

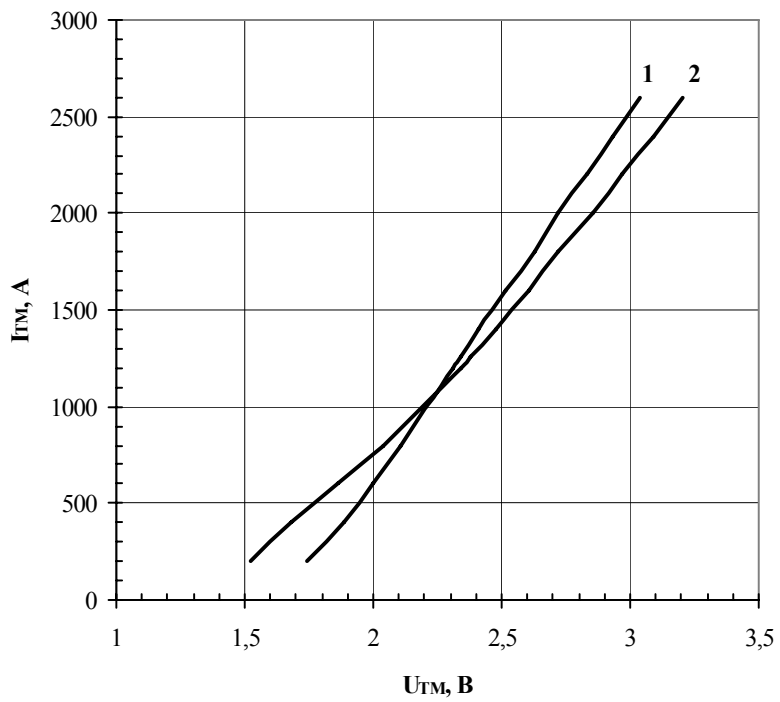
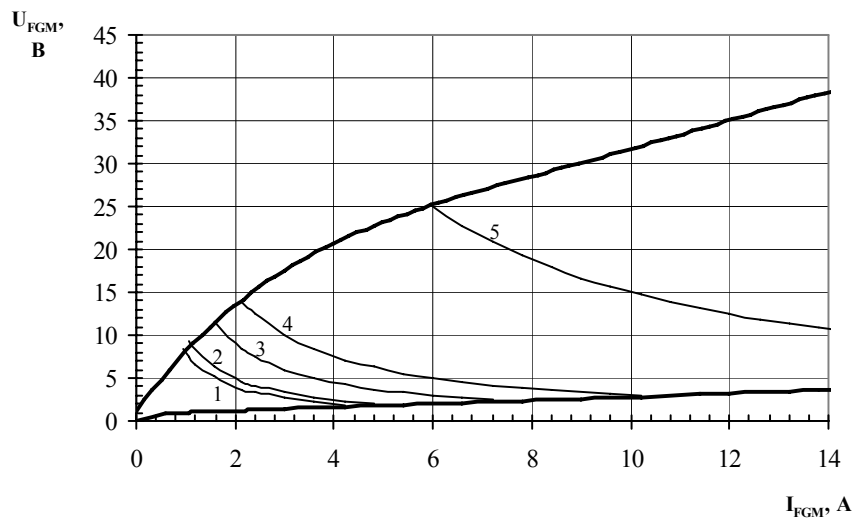

Fig. 1 On-state characteristics of Limit device

1 – $T_j = 25\text{ }^\circ\text{C}$
 2 – $T_j = 125\text{ }^\circ\text{C}$



Maximum peak gate power loss

Position	On-Off time ratio	Gate pulse length, ms	Gate Pulse Power, W
1	1	DC	8
2	2	10	10
3	20	1	18
4	40	0.5	30
5	200	0.1	150

Fig. 2 Gate characteristics

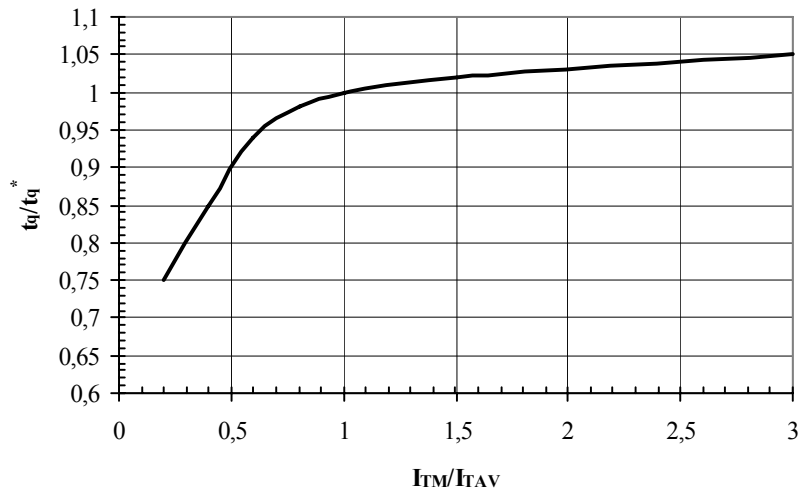

Fig. 3 Turn-off time t_q vs. On-state peak current I_{TM}

Conditions: $T_j=T_{j\max}$; $di_R/dt=10\text{ A}/\mu\text{s}$; $V_R=100\text{ V}$; $dv_D/dt=50\text{ V}/\mu\text{s}$; $V_D=0.67\cdot V_{DRM}$
 Typical changes of t_q are normalized to the t_q^* (t_q^* – see data sheet, $dv_D/dt=50\text{ V}/\mu\text{s}$)

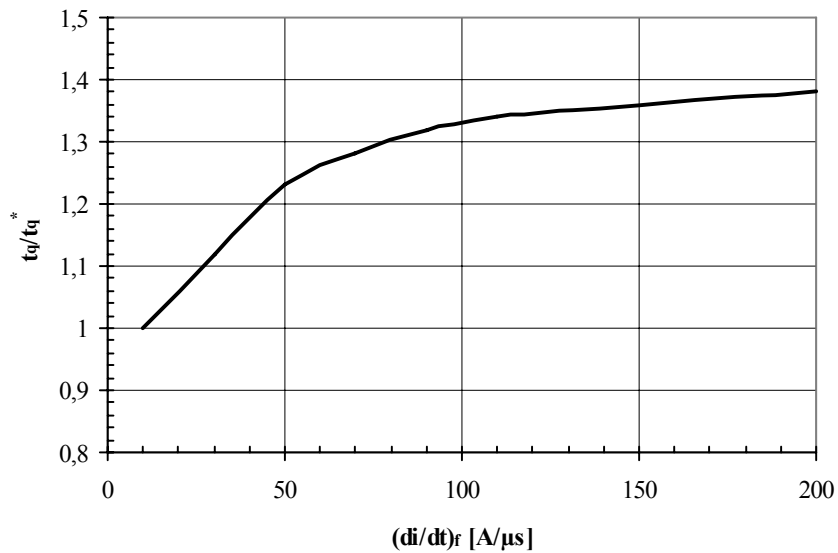

Fig. 4 Turn-off time t_q vs. Rate of fall of on-state current di_R/dt

Conditions: $T_j=T_{j\max}$; $I_{TM}=I_{TAV}$; $V_R=100\text{ V}$; $dv_D/dt=50\text{ V}/\mu\text{s}$; $V_D=0.67\cdot V_{DRM}$
 Typical changes of t_q are normalized to the t_q^* (t_q^* – see data sheet, $dv_D/dt=50\text{ V}/\mu\text{s}$)

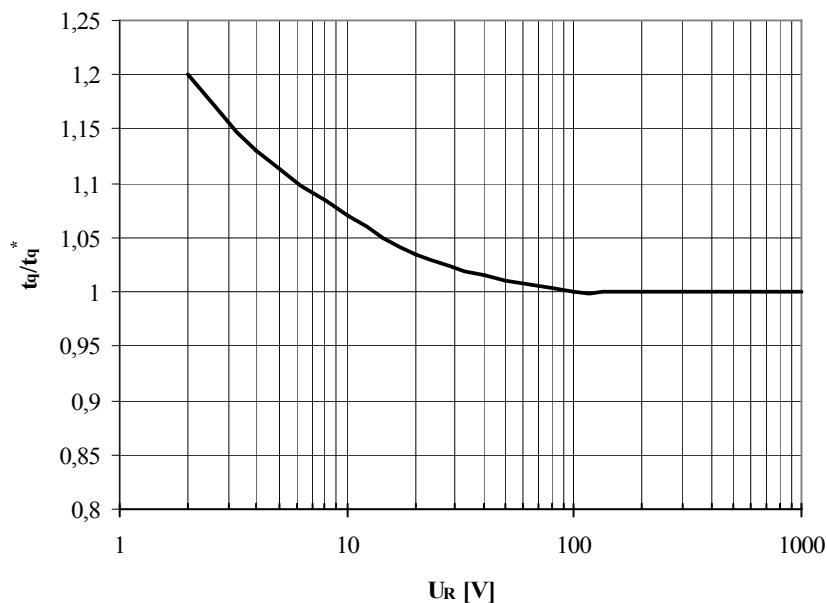

Fig. 5 Turn-off time t_q vs. Reverse voltage V_R

Conditions: $T_j=T_{j\max}$; $I_{TM}=I_{TAV}$; $di_R/dt=10\text{ A}/\mu\text{s}$; $dv_D/dt=50\text{ V}/\mu\text{s}$; $V_D=0.67\cdot V_{DRM}$
 Typical changes of t_q are normalized to the t_q^* (t_q^* – see data sheet, $dv_D/dt=50\text{ V}/\mu\text{s}$)

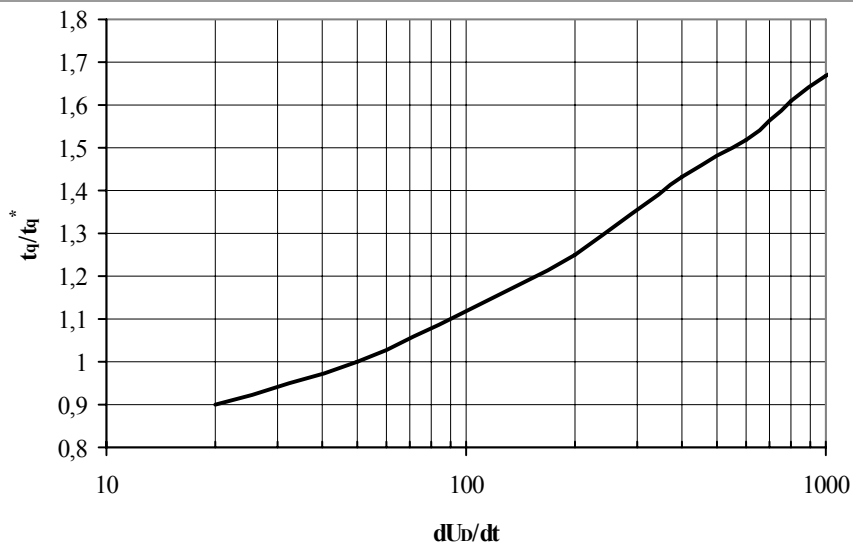

Fig. 6 Turn-off time t_q vs. Rate of rise of commutating voltage dv_D/dt

Conditions: $T_j=T_{j\max}$; $I_{TM}=I_{TAV}$; $di_R/dt=10\text{ A}/\mu\text{s}$; $V_R=100\text{ V}$; $V_D=0.67\cdot V_{DRM}$
 Typical changes of t_q are normalized to the t_q^* (t_q^* – see data sheet, $dv_D/dt=50\text{ V}/\mu\text{s}$)

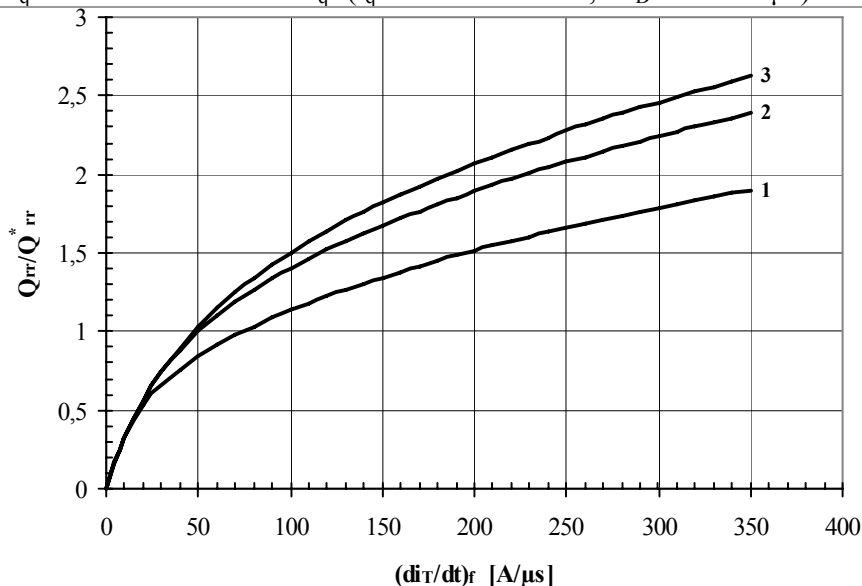

Fig. 7 Reverse recovery charge Q_{rr} , vs. Rate of fall of on-state current di_R/dt

- 1 – $I_{TM} = 0.5 \cdot I_{TAV}$
- 2 – $I_{TM} = I_{TAV}$,
- 3 – $I_{TM} = 1.5 \cdot I_{TAV}$

Conditions: $T_j=T_{j\max}$; $V_R=100\text{ V}$

Typical changes of Q_{rr} are normalized to the Q_{rr}^* (Q_{rr}^* – see data sheet)

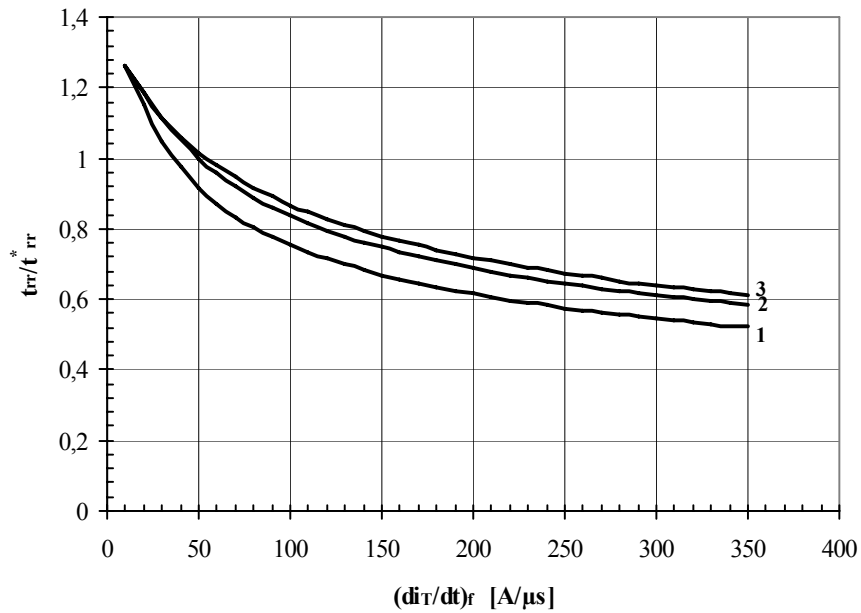

Fig. 8 Reverse recovery time t_{rr} vs. Rate of fall of on-state current di_R/dt

1 – $I_{TM} = 0.5 I_{TAV}$

2 – $I_{TM} = I_{TAV}$,

3 – $I_{TM} = 1.5 I_{TAV}$

Conditions: $T_j = T_{j \max}$; $V_R = 100$ V

Typical changes of t_{rr} are normalized to the t_{rr}^* (t_{rr}^* – see data sheet)

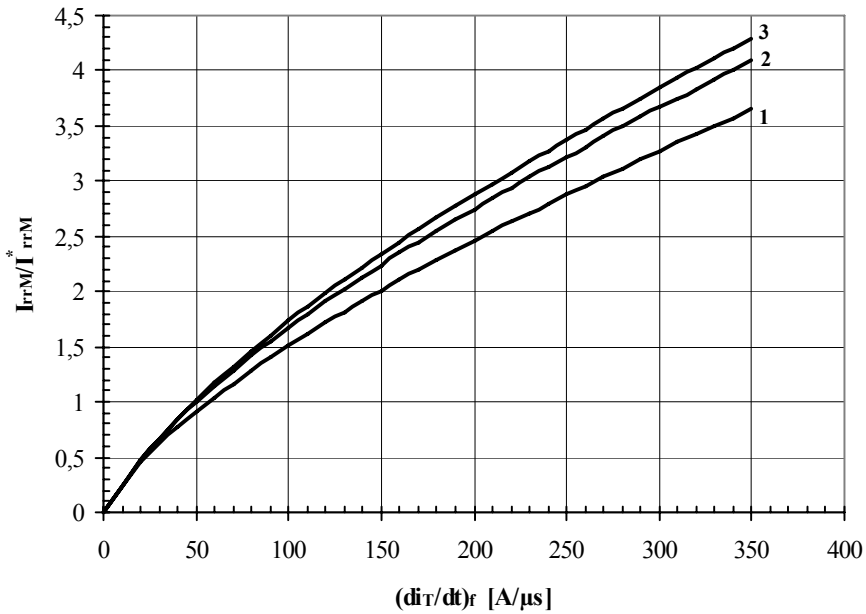

Fig. 9 Peak reverse recovery current I_{rrM} vs. Rate of fall of on-state current di_R/dt

1 – $I_{TM} = 0.5 I_{TAV}$

2 – $I_{TM} = I_{TAV}$,

3 – $I_{TM} = 1.5 I_{TAV}$

Conditions: $T_j = T_{j \max}$; $V_R = 100$ V

Typical changes of I_{rrM} are normalized to the I_{rrM}^* (I_{rrM}^* – see data sheet)

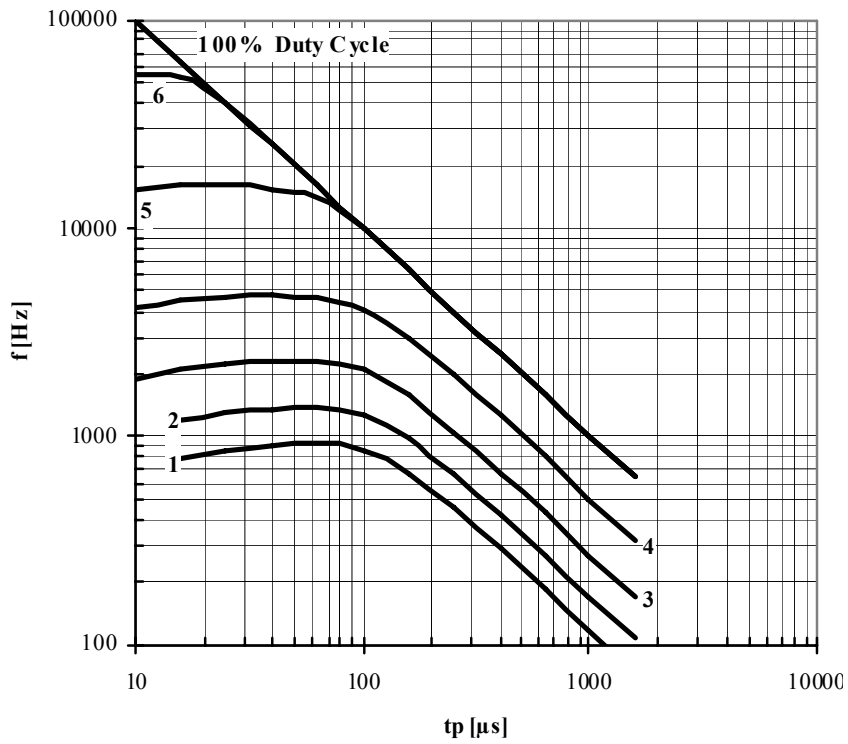

Fig. 10 Sine wave frequency ratings

- 1 – $I_{TM} = 5000$ A
- 2 – $I_{TM} = 4000$ A
- 3 – $I_{TM} = 3000$ A
- 4 – $I_{TM} = 2000$ A
- 5 – $I_{TM} = 1000$ A
- 6 – $I_{TM} = 500$ A

Conditions: $V_R \leq 3$ V; $T_C = 55$ °C

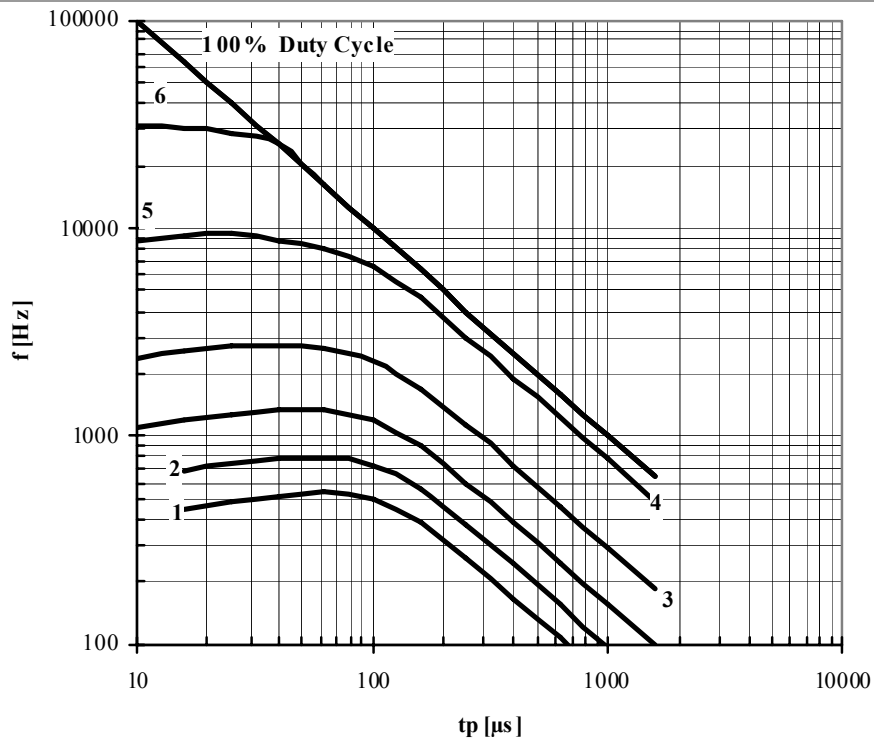

Fig. 11 Sine wave frequency ratings

- 1 – $I_{TM} = 5000\text{ A}$
- 2 – $I_{TM} = 4000\text{ A}$
- 3 – $I_{TM} = 3000\text{ A}$
- 4 – $I_{TM} = 2000\text{ A}$
- 5 – $I_{TM} = 1000\text{ A}$
- 6 – $I_{TM} = 500\text{ A}$

Conditions: $V_R \leq 3\text{ V}$; $T_C = 90\text{ }^\circ\text{C}$

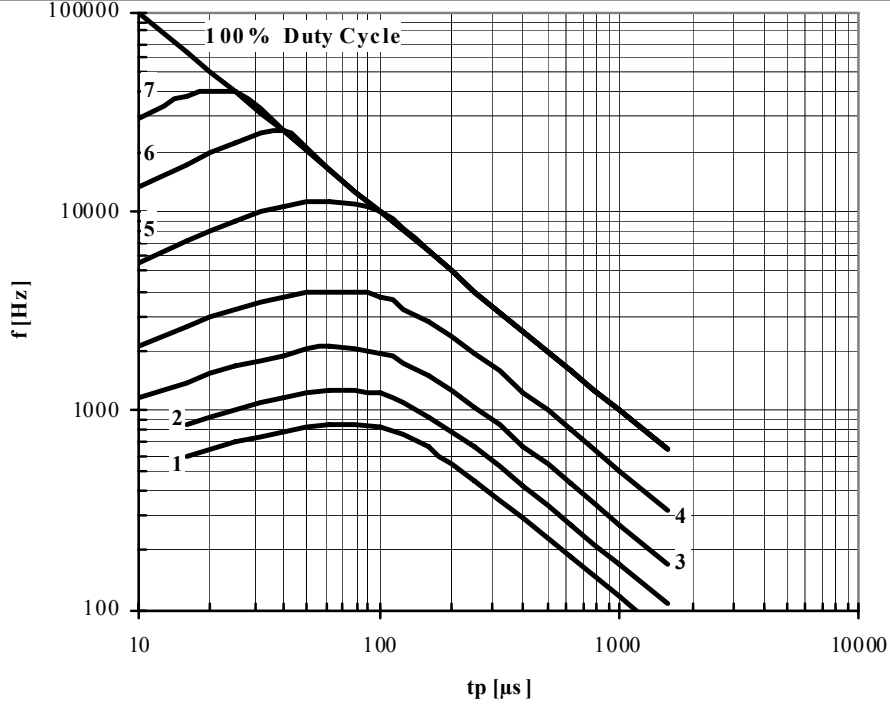

Fig. 12 Sine wave frequency ratings

- 1 – $I_{TM} = 5000\text{ A}$
- 2 – $I_{TM} = 4000\text{ A}$
- 3 – $I_{TM} = 3000\text{ A}$
- 4 – $I_{TM} = 2000\text{ A}$
- 5 – $I_{TM} = 1000\text{ A}$
- 6 – $I_{TM} = 500\text{ A}$
- 7 – $I_{TM} = 250\text{ A}$

Conditions: $V_R = 0.67 \cdot V_{RRM}$; $T_C = 55\text{ }^\circ\text{C}$

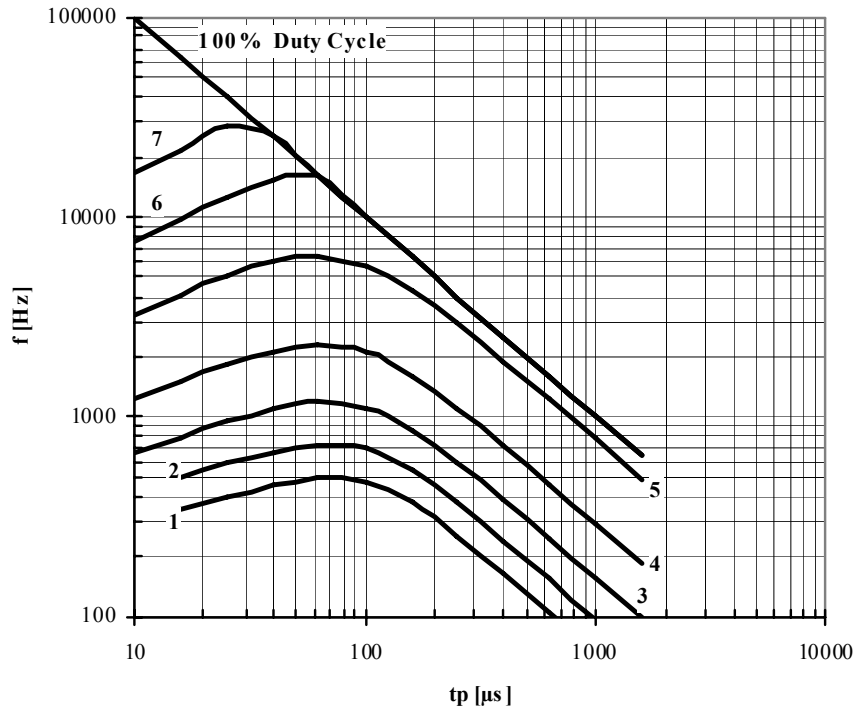

Fig. 13 Sine wave frequency ratings

- 1 – $I_{TM} = 5000$ A
- 2 – $I_{TM} = 4000$ A
- 3 – $I_{TM} = 3000$ A
- 4 – $I_{TM} = 2000$ A
- 5 – $I_{TM} = 1000$ A
- 6 – $I_{TM} = 500$ A
- 7 – $I_{TM} = 250$ A

Conditions: $V_R = 0.67 \cdot V_{RRM}$; $T_C = 90$ °C

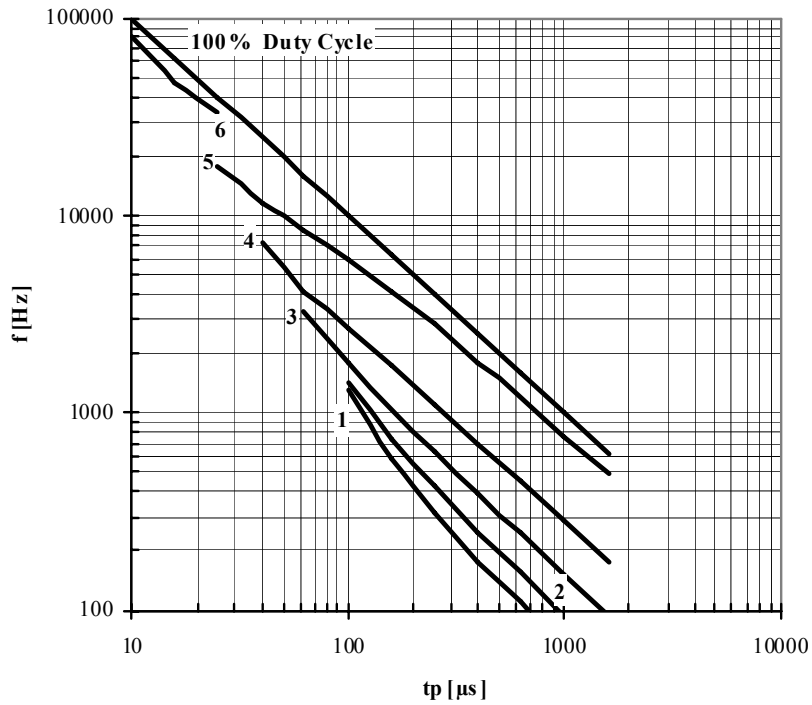

Fig. 14 Square wave frequency ratings

- 1 – $I_{TM} = 5000$ A
- 2 – $I_{TM} = 4000$ A
- 3 – $I_{TM} = 3000$ A
- 4 – $I_{TM} = 2000$ A
- 5 – $I_{TM} = 1000$ A
- 6 – $I_{TM} = 500$ A

Conditions: $V_R \leq 3 \text{ V}$; $T_C = 55 \text{ }^\circ\text{C}$; $di_F/dt = di_R/dt = 100 \text{ A}/\mu\text{s}$

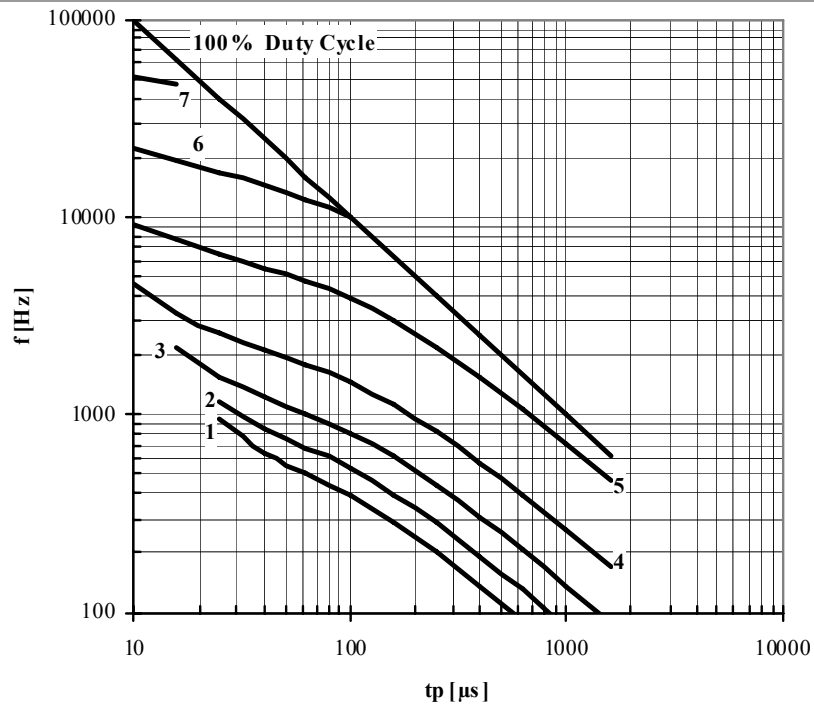

Fig. 15 Square wave frequency ratings

- 1 - $I_{TM} = 5000 \text{ A}$
- 2 - $I_{TM} = 4000 \text{ A}$
- 3 - $I_{TM} = 3000 \text{ A}$
- 4 - $I_{TM} = 2000 \text{ A}$
- 5 - $I_{TM} = 1000 \text{ A}$
- 6 - $I_{TM} = 500 \text{ A}$
- 7 - $I_{TM} = 250 \text{ A}$

Conditions: $V_R \leq 3 \text{ V}$; $T_C = 55 \text{ }^\circ\text{C}$; $di_F/dt = di_R/dt = 500 \text{ A}/\mu\text{s}$

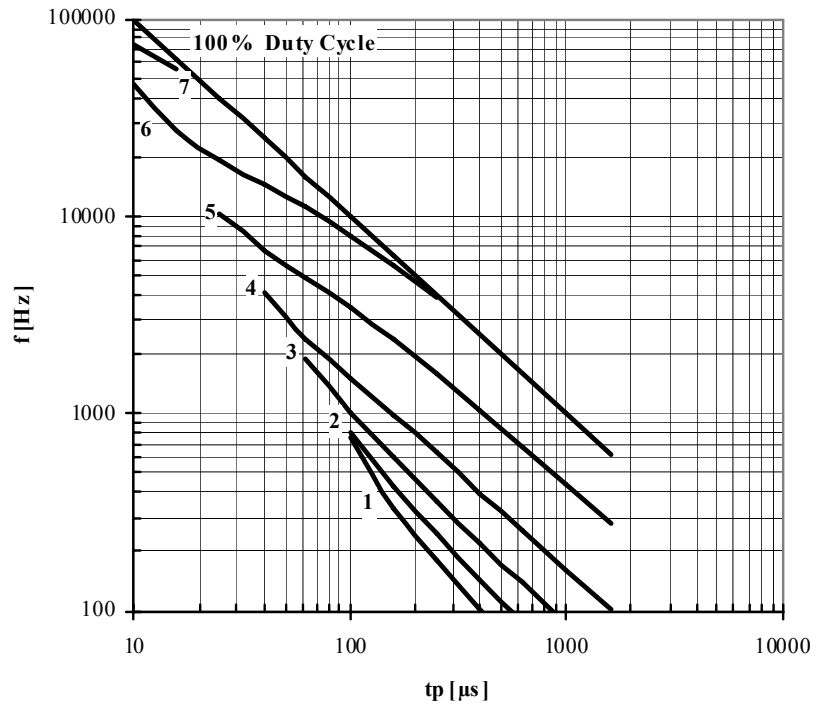

Fig. 16 Square wave frequency ratings

- 1 - $I_{TM} = 5000$ A
- 2 - $I_{TM} = 4000$ A
- 3 - $I_{TM} = 3000$ A
- 4 - $I_{TM} = 2000$ A
- 5 - $I_{TM} = 1000$ A
- 6 - $I_{TM} = 500$ A
- 7 - $I_{TM} = 250$ A

Conditions: $V_R \leq 3$ V; $T_C = 90$ °C; $di_F/dt = di_R/dt = 100$ A/ μ s

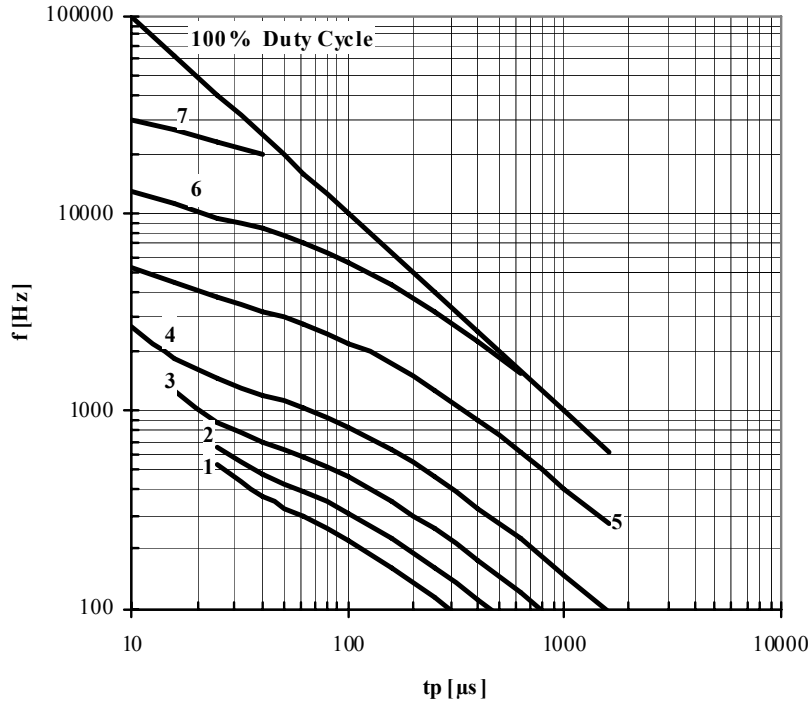

Fig. 17 Square wave frequency ratings

- 1 - $I_{TM} = 5000$ A
- 2 - $I_{TM} = 4000$ A
- 3 - $I_{TM} = 3000$ A
- 4 - $I_{TM} = 2000$ A
- 5 - $I_{TM} = 1000$ A
- 6 - $I_{TM} = 500$ A
- 7 - $I_{TM} = 250$ A

Conditions: $V_R \leq 3$ V; $T_C = 90$ °C; $di_F/dt = di_R/dt = 500$ A/ μ s

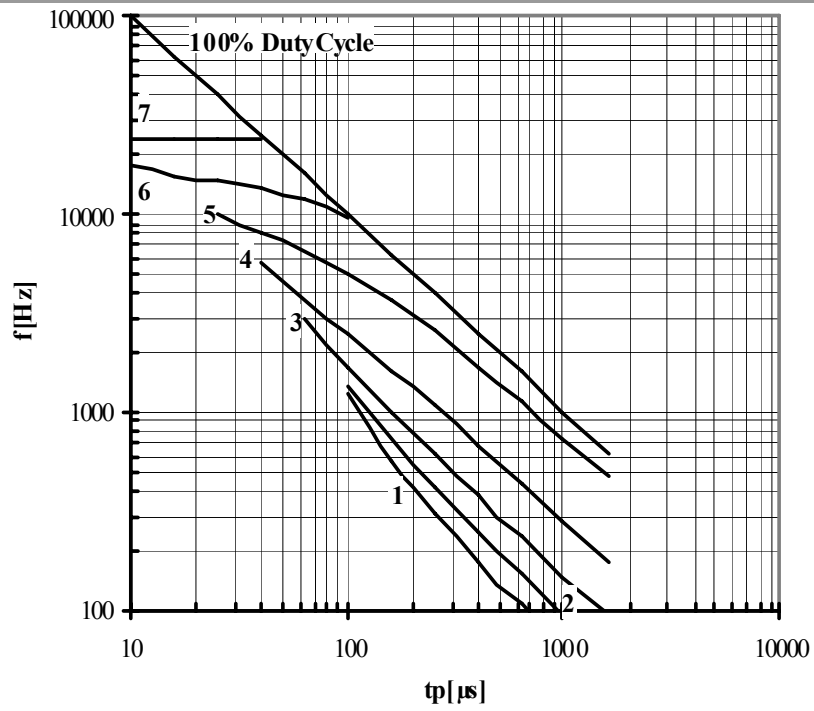

Fig. 18 Square wave frequency ratings

- 1 – $I_{TM} = 5000 \text{ A}$
- 2 – $I_{TM} = 4000 \text{ A}$
- 3 – $I_{TM} = 3000 \text{ A}$
- 4 – $I_{TM} = 2000 \text{ A}$
- 5 – $I_{TM} = 1000 \text{ A}$
- 6 – $I_{TM} = 500 \text{ A}$
- 7 – $I_{TM} = 250 \text{ A}$

Conditions: $V_R = 0.67 V_{RRM}$; $T_C = 55 \text{ }^\circ\text{C}$; $di_F/dt = di_R/dt = 100 \text{ A}/\mu\text{s}$

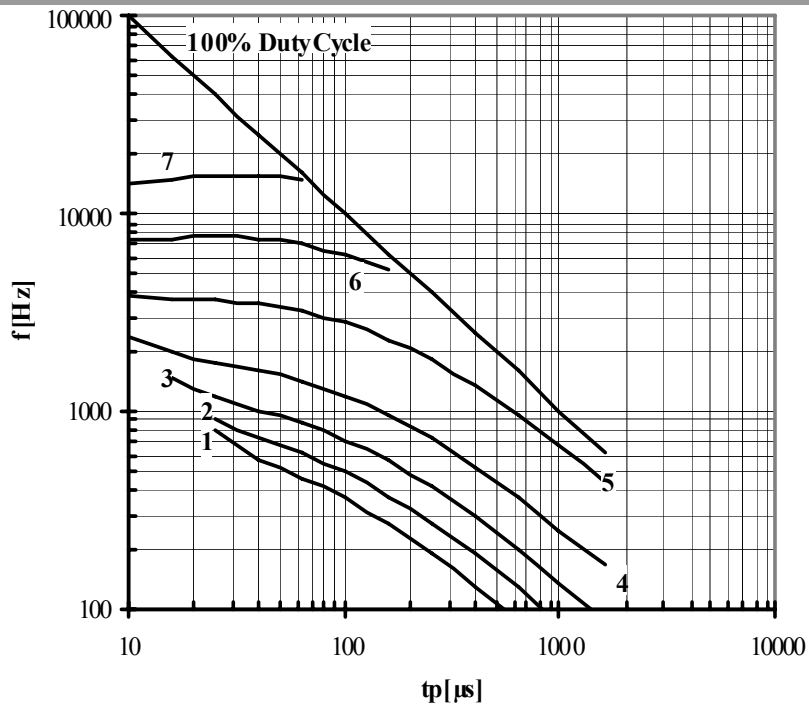

Fig. 19 Square wave frequency ratings

- 1 – $I_{TM} = 5000$ A
- 2 – $I_{TM} = 4000$ A
- 3 – $I_{TM} = 3000$ A
- 4 – $I_{TM} = 2000$ A
- 5 – $I_{TM} = 1000$ A
- 6 – $I_{TM} = 500$ A
- 7 – $I_{TM} = 250$ A

Conditions: $V_R = 0.67 \cdot V_{RRM}$; $T_C = 55$ °C; $di_F/dt = di_R/dt = 500$ A/μs

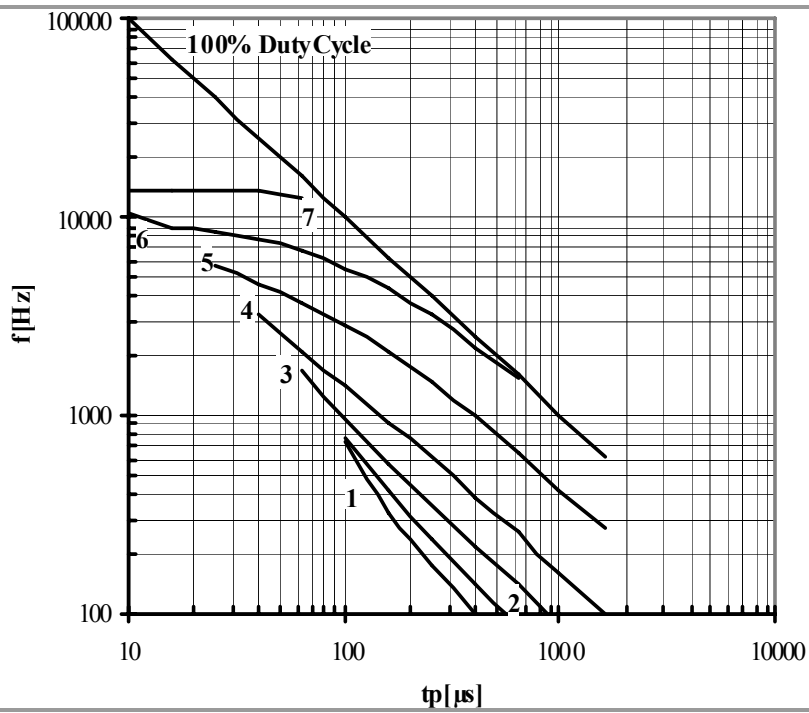

Fig. 20 Square wave frequency ratings

- 1 - $I_{TM} = 5000$ A
- 2 - $I_{TM} = 4000$ A
- 3 - $I_{TM} = 3000$ A
- 4 - $I_{TM} = 2000$ A
- 5 - $I_{TM} = 1000$ A
- 6 - $I_{TM} = 500$ A
- 7 - $I_{TM} = 250$ A

Conditions: $V_R = 0.67 \cdot V_{RRM}$; $T_C = 90$ °C; $di_F/dt = di_R/dt = 100$ A/ μ s

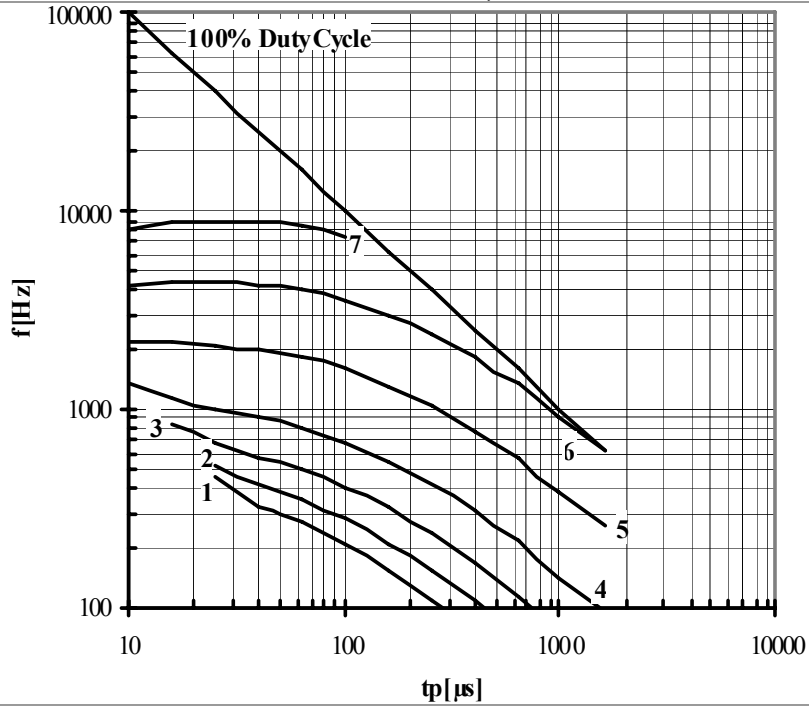

Fig. 21 Square wave frequency ratings

- 1 - $I_{TM} = 5000$ A
- 2 - $I_{TM} = 4000$ A
- 3 - $I_{TM} = 3000$ A
- 4 - $I_{TM} = 2000$ A
- 5 - $I_{TM} = 1000$ A
- 6 - $I_{TM} = 500$ A
- 7 - $I_{TM} = 250$ A

Conditions: $V_R = 0.67 \cdot V_{RRM}$; $T_C = 90$ °C; $di_F/dt = di_R/dt = 500$ A/ μ s

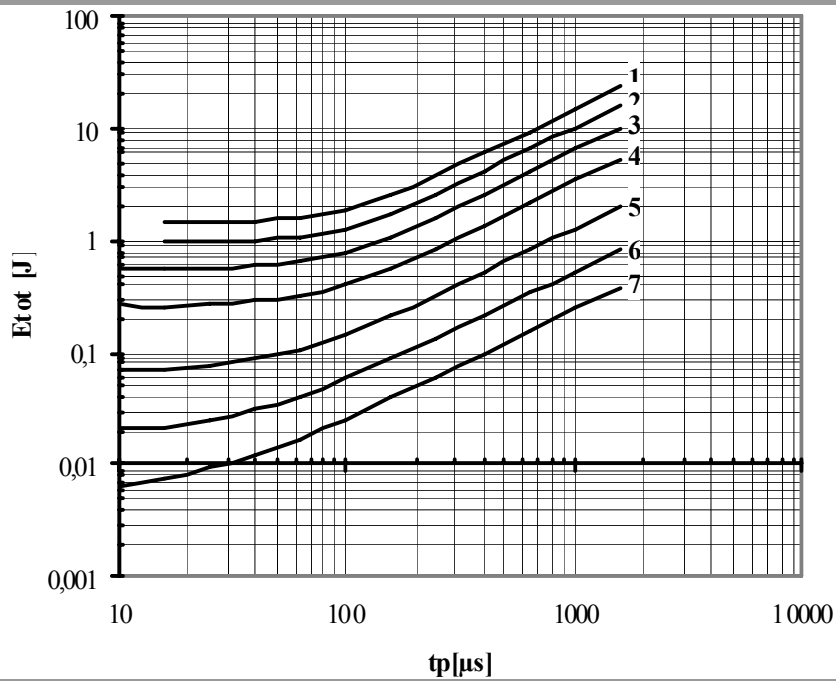

Fig. 22 Sine wave loss energy per pulse

- 1 – $I_{TM} = 5000$ A
- 2 – $I_{TM} = 4000$ A
- 3 – $I_{TM} = 3000$ A
- 4 – $I_{TM} = 2000$ A
- 5 – $I_{TM} = 1000$ A
- 6 – $I_{TM} = 500$ A
- 7 – $I_{TM} = 250$ A

Conditions: $V_R \leq 3$ V

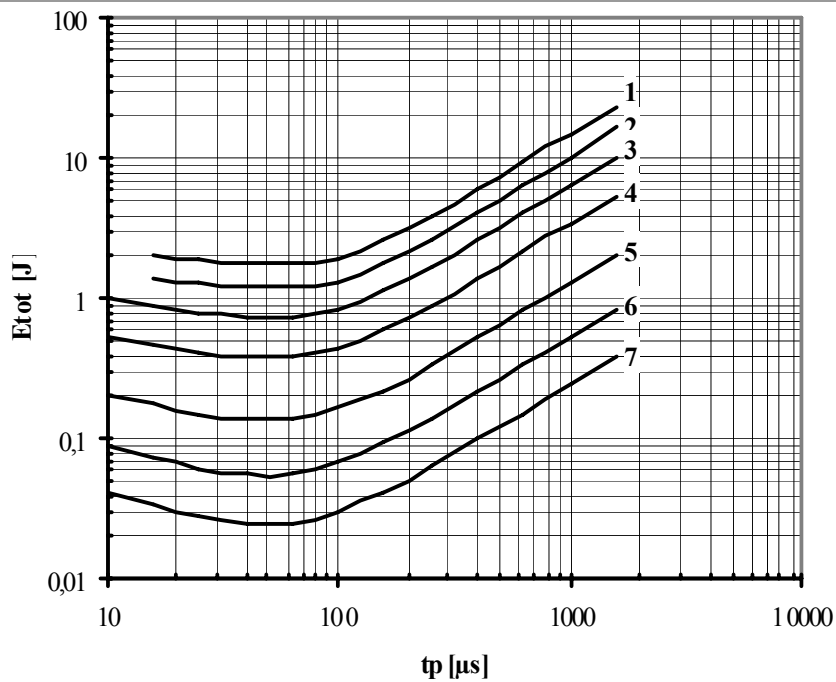

Fig. 23 Sine wave loss energy per pulse

- 1 – $I_{TM} = 5000$ A
- 2 – $I_{TM} = 4000$ A
- 3 – $I_{TM} = 3000$ A
- 4 – $I_{TM} = 2000$ A
- 5 – $I_{TM} = 1000$ A
- 6 – $I_{TM} = 500$ A
- 7 – $I_{TM} = 250$ A

Conditions: $V_R = 0.67 \cdot V_{RRM}$

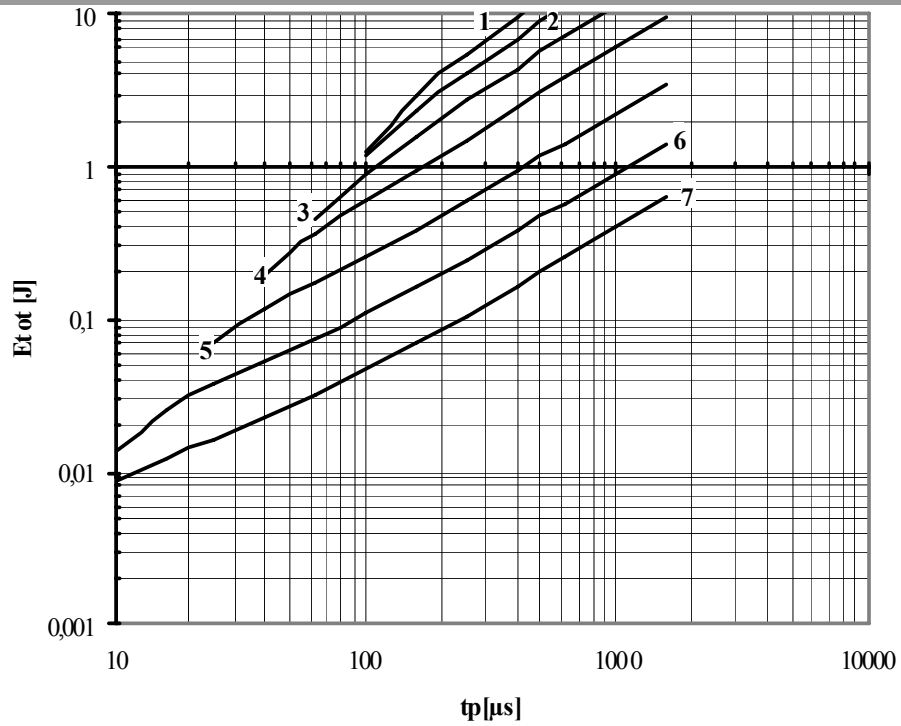

Fig. 24 Square wave loss energy per pulse

- 1 – $I_{TM} = 5000$ A
- 2 – $I_{TM} = 4000$ A
- 3 – $I_{TM} = 3000$ A
- 4 – $I_{TM} = 2000$ A
- 5 – $I_{TM} = 1000$ A
- 6 – $I_{TM} = 500$ A
- 7 – $I_{TM} = 250$ A

Conditions: $V_R \leq 3$ V; $di_F/dt = di_R/dt = 100$ A/ μ s

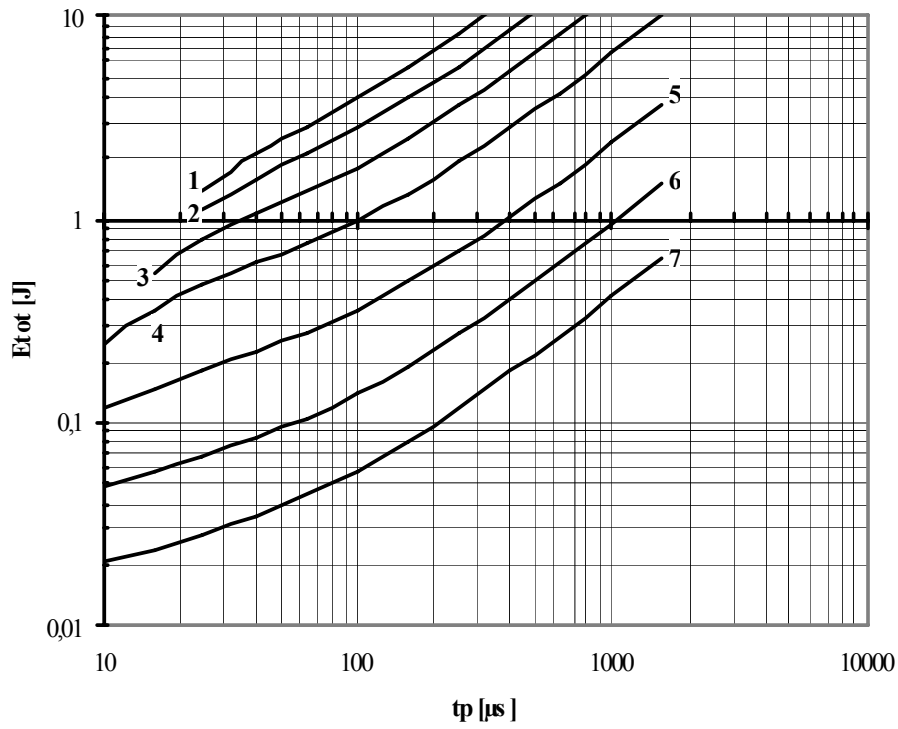

Fig. 25 Square wave loss energy per pulse

- 1 – $I_{TM} = 5000$ A
- 2 – $I_{TM} = 4000$ A
- 3 – $I_{TM} = 3000$ A
- 4 – $I_{TM} = 2000$ A
- 5 – $I_{TM} = 1000$ A
- 6 – $I_{TM} = 500$ A
- 7 – $I_{TM} = 250$ A

Conditions: $V_R \leq 3$ V; $di_F/dt = di_R/dt = 500$ A/ μ s

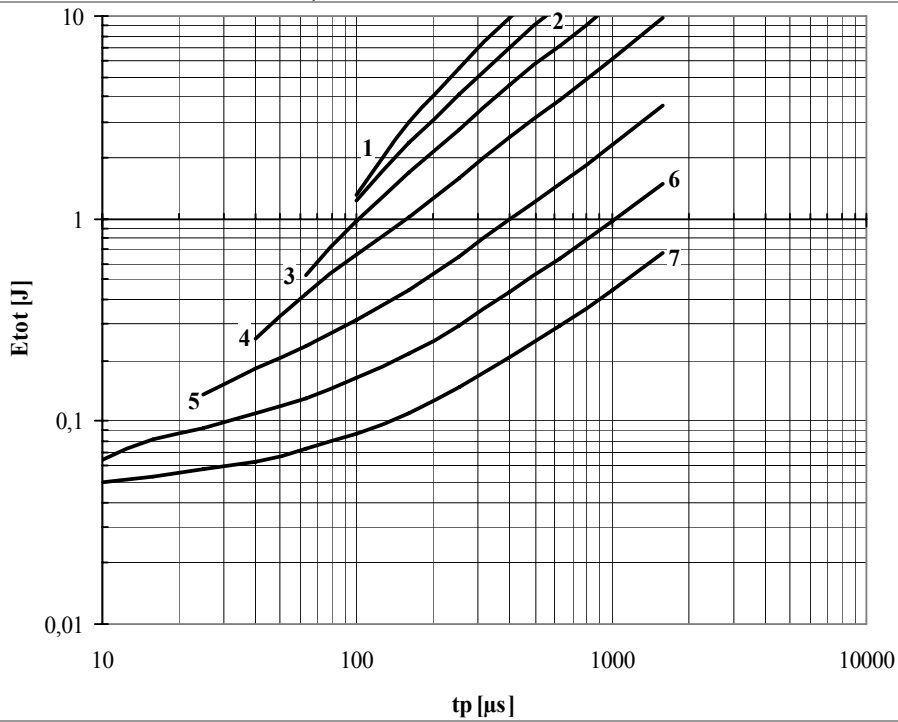

Fig. 26 Square wave loss energy per pulse

- 1 – $I_{TM} = 5000$ A
- 2 – $I_{TM} = 4000$ A
- 3 – $I_{TM} = 3000$ A
- 4 – $I_{TM} = 2000$ A
- 5 – $I_{TM} = 1000$ A
- 6 – $I_{TM} = 500$ A
- 7 – $I_{TM} = 250$ A

Conditions: $V_R = 0.67 \cdot V_{RRM}$; $di_F/dt = di_R/dt = 100$ A/ μ s

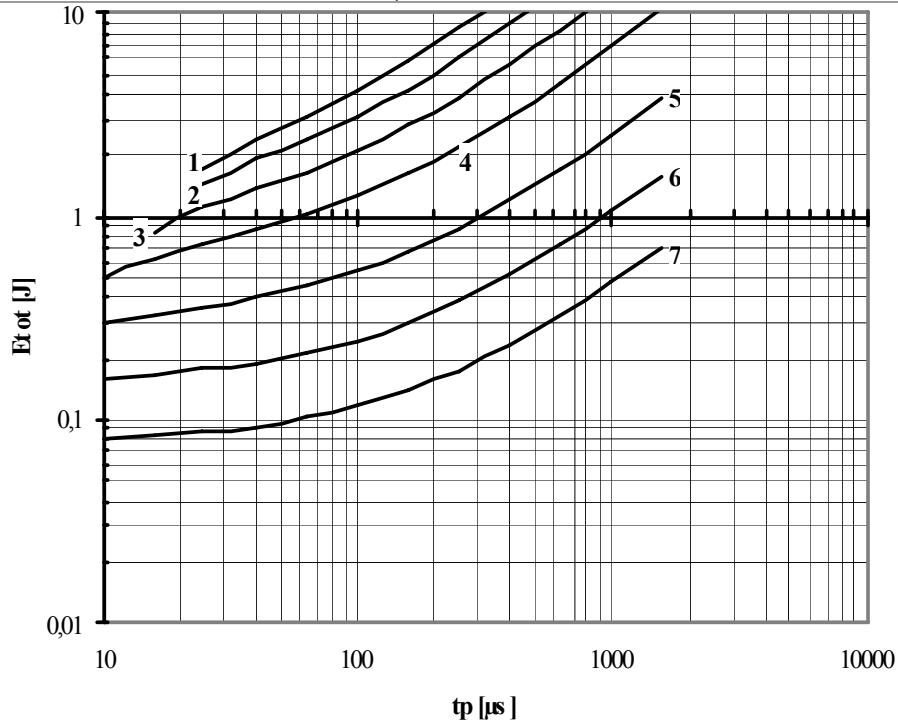

Fig. 27 Square wave loss energy per pulse

- 1 – $I_{TM} = 5000$ A
- 2 – $I_{TM} = 4000$ A
- 3 – $I_{TM} = 3000$ A
- 4 – $I_{TM} = 2000$ A
- 5 – $I_{TM} = 1000$ A
- 6 – $I_{TM} = 500$ A
- 7 – $I_{TM} = 250$ A

Conditions: $V_R = 0.67 \cdot V_{RRM}$; $di_F/dt = di_R/dt = 500$ A/ μ s

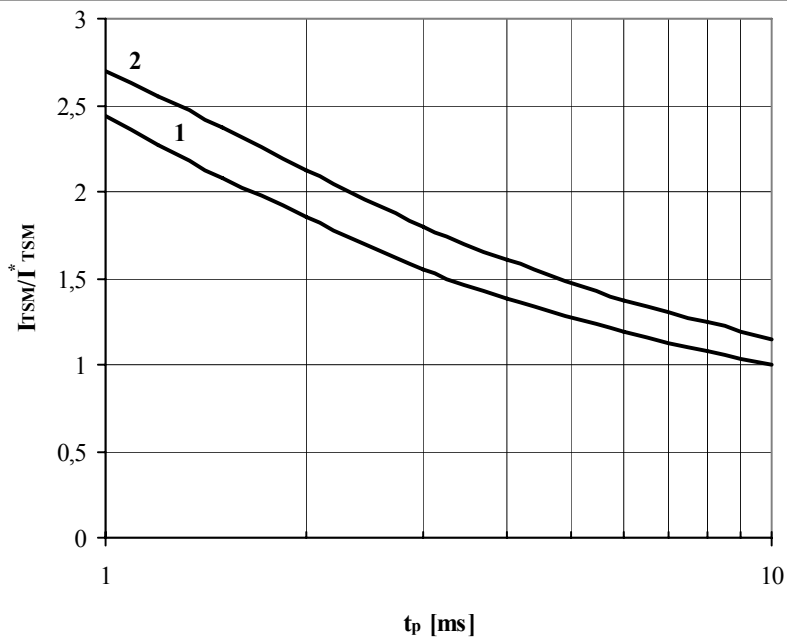

Fig. 28 The surge current I_{TSM} vs. Duration of surge t_p for a half-sine wave
 1 – $T_j=125\text{ °C}$
 2 – $T_j=25\text{ °C}$

Conditions: $V_R=0\text{ V}$ – the peak value of reverse voltage which is applied immediately after the surge current

Typical changes of I_{TSM} are normalized to the I_{TSM}^* (I_{TSM}^* – see data sheet, $T_j=T_{j\text{ max}}$)

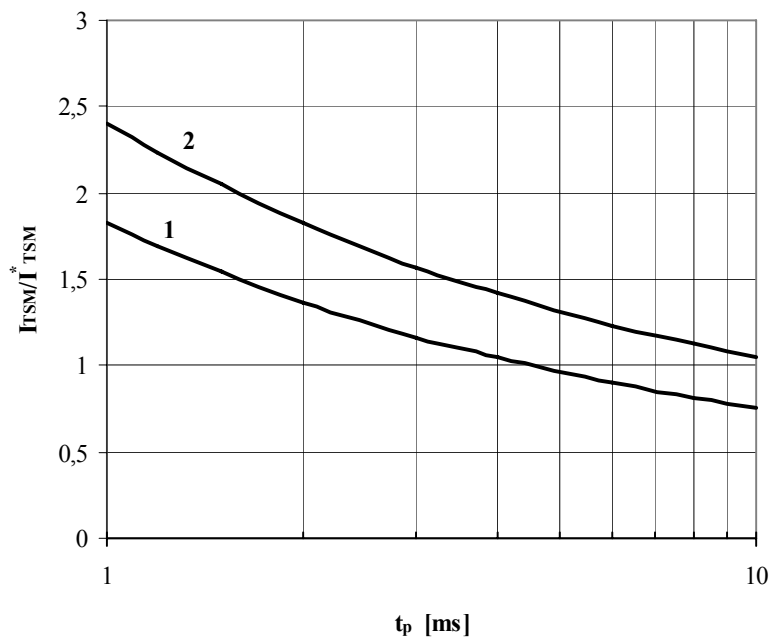

Fig. 29 The surge current I_{TSM} vs. Duration of surge t_p for a half-sine wave
 1 – $T_j=125\text{ °C}$
 2 – $T_j=25\text{ °C}$

Conditions: $V_R=0.8 \cdot V_{RRM}$ – the peak value of reverse voltage which is applied immediately after the surge current

Typical changes of I_{TSM} are normalized to the I_{TSM}^* (I_{TSM}^* – see data sheet, $T_j=T_{j\text{ max}}$)

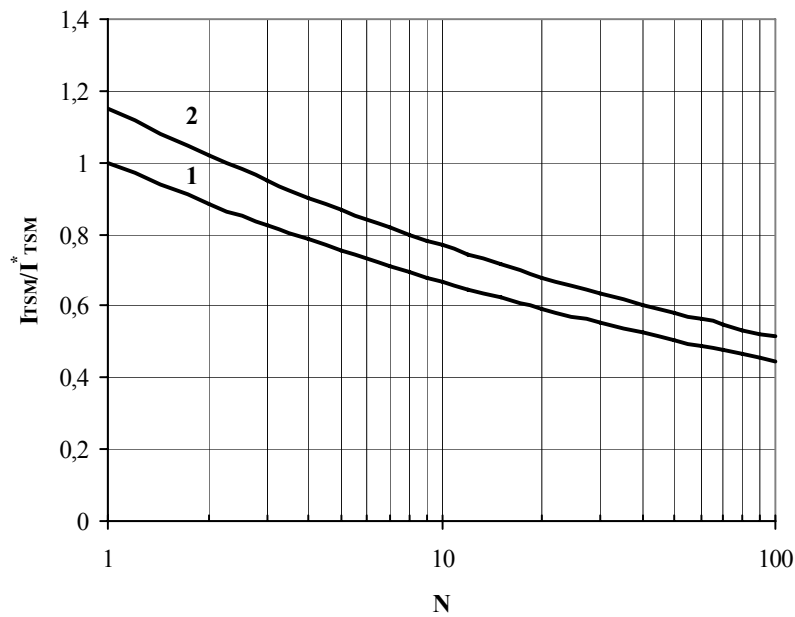

Fig. 30 The surge current I_{TSM} vs. Number of half-sine waves at 50 Hz
 1 – $T_j=125\text{ }^\circ\text{C}$
 2 – $T_j=25\text{ }^\circ\text{C}$

Conditions: $V_R=0\text{ V}$ – the peak value of reverse voltage which is applied immediately after the surge current

Typical changes of I_{TSM} are normalized to the I_{TSM}^* (I_{TSM}^* – see data sheet, $T_j=T_{j\text{max}}$)

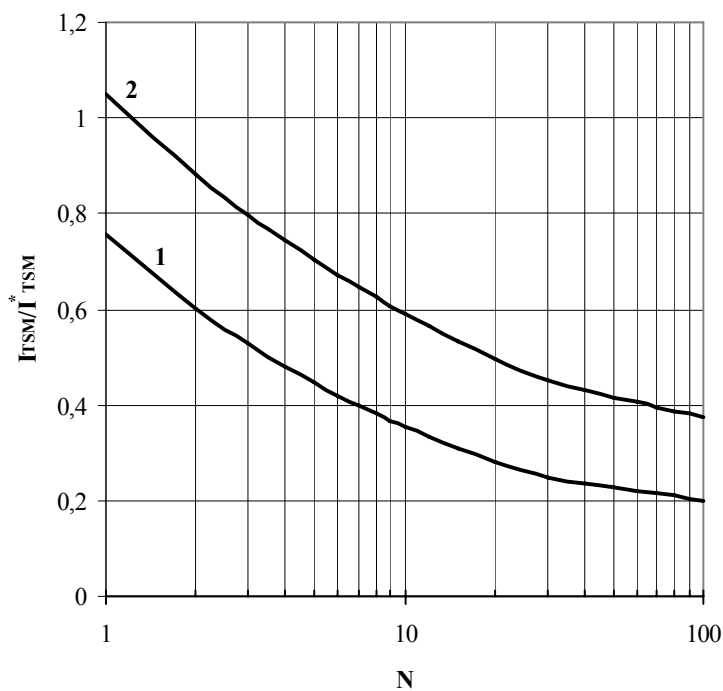

Fig. 31 The surge current I_{TSM} vs. Number of half-sine waves at 50 Hz
 1 – $T_j=125\text{ }^\circ\text{C}$
 2 – $T_j=25\text{ }^\circ\text{C}$

Conditions: $V_R=0.8 \cdot V_{RRM}$ – the peak value of reverse voltage which is applied immediately after the surge current

Typical changes of I_{TSM} are normalized to the I_{TSM}^* (I_{TSM}^* – see data sheet, $T_j=T_{j\text{max}}$)